





DETAILS ROOM 14

including technical specifications and seating configurations

Areas/rooms	Area in m ²	 Theater	 Classroom	 Banquet	 Beer fest
Room 14	2,730	3,000	1,464	1,500	1,592
Room 14a large	624	630	300	320	-
Room 14a small	450	464	220	240	-
Room 14b large	1,565	1,482	784	826	-
Room 14b small	1,120	1,050	524	558	-
Room 14c large	624	630	300	320	-
Room 14c small	450	464	220	240	-

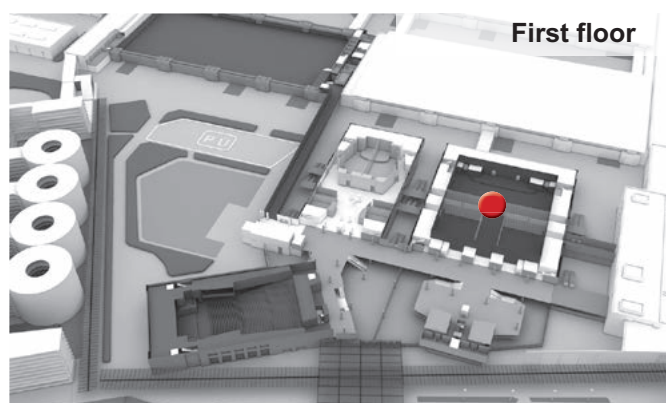

Room 14: Multitalent for international Events

Our multi-functional Room 14 can accommodate up to 3,000 seats in 43 rows. It is equipped with state-of-the-art technology and features interpreter’s booths, control booths and movie screens. Six moveable lighting grids permit sophisticated lighting effects in all areas. Six skylights let daylight into the large room, which can also be completely darkened. The ceiling height is an impressive 9.50 m. Due to partition walls, Room 14 can be divided into three smaller soundproof rooms, making it ideal for conventions, shows, presentations and gala events. Room 14 in the smaller or the large version is particularly suitable for conferences, conventions, product launches, shows and events.

Rooms 14a large and 14c large: Perfect for Events with around 630 Guests

The two Rooms 14a and 14c, each with 624 m², offer a capacity of 630 theater style seats, 300 classroom-style seats and 320 seats in banquet format. Both rooms receive natural light through skylights and can be completely darkened.

Rooms 14a small and 14c small: Perfect for Events with around 464 Guests

The two Rooms 14a and 14c, each with 450 m², offer a capacity of 464 theater style seats, 220 classroom-style seats and 240 seats in banquet format. Both rooms receive natural light through skylights and can be completely darkened.

Room 14b large: Perfect for Events with up to 1,482 Guests

In its large version, Room 14b provides 1,565 m² with a capacity of 1,482 people in theater seating, 784 seats in classroom style seating or 826 seats in banquet form. The room receives natural light through four skylights and can be completely darkened as needed.

Room 14b small: Perfect for Events with around 1,050 Guests

The smaller version of Room 14b with 1,120 m² provides you a capacity of 1,050 row seats, 524 classroom style seats or 558 seats in banquet layout. The room receives natural light through four skylights and can be completely darkened if needed.

Specifications	
Location	<ul style="list-style-type: none"> Deliveries via two elevators (length 6.10 m, width 3.20 m, height 2.50 m, max. 4,000 kg) next to stage Elevators loaded at ground level (behind Hall B0) and lower level (tunnel). Elevators stop at room level and stage level.
Suitable for	<ul style="list-style-type: none"> Rooms 14 and 14b: Conventions, shows, gala events, product presentations, events Rooms 14a and 14c: Lecture events, presentations, meetings, conferences
Size/capacity	<ul style="list-style-type: none"> Room 14: 2,730 m², seats 3,000 people in theater seating, 1,464 people with classroom seating, 1,500 people with banquet seating Rooms 14a large and 14c large: 624 m² each; each room seat 630 people in theater seating, 300 people with classroom seating, 320 people with banquet seating Rooms 14a small and 14c small: 450 m² each; each room seat 464 people in theater seating, 220 people with classroom seating, 240 people with banquet seating Room 14b large: 1,565 m², seats 1,482 people in theater seating, 784 people with classroom seating, 826 people with banquet seating Room 14b small: 1,120 m², seats 1,050 people in theater seating, 524 people with classroom seating, 558 people with banquet seating
Special features	<ul style="list-style-type: none"> Daylight through 6 skylights (4 skylights in Room 14b large, 3 skylights in Room 14b small), can be completely darkened. Room height: 9.50 m Color of room: Traffic blue (RAL 5017) Rooms 14 and 14b: Performer dressing rooms: 3 group dressing rooms, 3 private dressing rooms Rooms 14a and 14c: No fixed stage Permissible floor load: 500 kg/m² (5 kN/m²)
Room partitions	<ul style="list-style-type: none"> Room 14 can be partitioned into up to three smaller rooms. Ceiling-high partitions make the smaller rooms soundproof. Partitions that are not in use disappear into special storage compartments.
Stage (Rooms 14 and 14b)	<ul style="list-style-type: none"> The front edge of the stage is slightly curved (r = 151 m). If additional platforms are used to extend the stage, the front edge can also be “straightened.” This extends the depth of the stage by one meter in the middle. Proscenium panels can also be used to reduce the width of the stage. Fixed stage, 123 m² in size Stage width: 19.90 m Stage depth: 6.20 m (can be increased to 9.20 m with retractable platforms) Platform height: 1.20 m Clearance height on stage: 7 m The height of the retractable platforms can be adjusted between 0.80 m and 1.20 m.

Specifications

Stage stairway
(Rooms 14 and 14b)

- A stage stairway that spans the width of the entire stage (19.90 m) can also be added. It consists of 7 elements that can be set up at a height of 120 cm, 100 cm or 80 cm. Each element is 2.88 m long and curved to fit the front edge of the stage. The elements can also be set up on top of one another to create a long stairway into the stage. Each step is equipped with LEDs (red, green, blue) which can be used to create any color.

Curtain
(Rooms 14 and 14b)

- The performance curtain is a traveler curtain (opens to the sides) made of stage velour that is the same color as the room. Various legs and borders made of black stage velour are also available.

Overhead machinery
(Rooms 14 and 14b)

Stage:

- 3 machine hoists: 500 kg/hoist (length 18.20 m, 60 mm pipe)
- 3 lighting hoists: 500 kg/hoist (length 18.20 m, 60 mm pipe)
- 12 chain hoists: 500 kg/hoist (in accordance with BGV C1) arranged on 3 rails, can be positioned using motors.

Room:

24 chain hoist:

- 500 kg/hoist (in accordance with BGV C1), can be positioned on a rail system above the room ceiling. The chains are lowered into the room through grommets. The chain hoists themselves can not be moved during scenery changes. Sixteen (16) mobile 1,000 kg BGV D8 rigging chain hoists can also be installed (max. 500 kg per point).

6 lighting bridges (4 in Room 14b large and 3 in Room 14b small):

- Each installed in the skylights
- Max. traverse: approx. 12 m, memory function to save positions
- Working load: 250 kg/m²

3 gondola hoists:

- Installed in front lighting bridges (e.g. for video projectors)
- 250 kg/winch

Overhead machinery
(Rooms 14a and 14c)

Chain hoists:

- 500 kg/hoist (in accordance with BGV C1), can be fixed to a series of rails above the ceiling. The chains are lowered into the room through grommets.

1 lighting bridge per room:

- Installed in skylight
- Max. traverse: approx. 12 m, memory function to save positions.
- Working load: 250 kg/m²

Specifications

Screens/projection

- The room is equipped with a total of three screens for front projection (1 screen in Room 14b). A truss with a retractable screen is installed on stage that can be positioned at any depth on stage. The screen has a visible projection area of 16.30 m x 6.50 m (w x h). There are two retractable screens for partitioned Rooms 14a and 14c, each with a visible projection area of 8 m x 9,60 m (w x h). Upon request, additional portable screens in various sizes (4.80 m x 6.30 m, 3 m x 4 m for front and rear projection) are also available. A rear-projection booth is located on the back wall of the stage where video projectors can be installed if needed. Direct connections to the stage and to the video control console are available.
Additional portable screens for front and rear projection are also available and can be hoisted using trusses.

Control booths

- Three control booths, i.e. for audio, video and lighting, are located at the back of the room. When the room is partitioned, the audio control booth is in Room 14a, and the lighting control booth is in Room 14c. Depending on technical requirements, the control booth in each room can be controlled from the other control booth, or a mobile control panel can be installed. In any case, a mobile audio/lighting control panel is installed in Room 14b.

Media equipment

- Room 14 is outfitted with a digital 72+8-channel mixing console and an L'Acoustics sound system.
Depending on the required configuration, the partitioned rooms 14a, 14b and 14c can be fitted with media technology and feature an L'Acoustics sound system.
- 12-channel UHF microphone system
 - Digital interpretation system
 - A line-source array can be installed if required.
 - Additional media technology can be installed in partitioned rooms.
 - Audio and video cross-connections into other halls and rooms possible

Specifications

Lighting

- The room is equipped with a dimmable general lighting system with halogen downlights and strip lights. The stage lighting system is equipped with 2 kW and 5 kW dimmers. A variety of lamps (e.g. Fresnel-lens, profile and PAR spotlights) are available. Multifunctional spotlights and portable dimmers can be controlled via the existing DMX network. A Grand MA 2 Light (upon request, with a Grand MA 2 is available as a backup console) is available as a lighting console. The room also has two permanently installed DMX 512 lines. Appropriate sockets are available at all important lighting positions. If necessary, network nodes (MA Lighting 4-Port-Node) can be used to expand the channel capacity.

Permanent spotlight locations:

- 6 lighting bridges (4 in Room 14b large, 3 in Room 14b small and 1 in Rooms 14a and 14c)
- 9 lighting stands on interpreter and control booths (4 in Room 14b large and 2 in Rooms 14a, 14c and 14b small)
- Rooms 14 and 14b: Bridge scaffolding (stage)
- Rooms 14 and 14b: Gallery left and right (stage)
- Rooms 14 and 14b: 3 lighting hoists



Power supply

- All lighting positions have electrical outlets for additional dimmers and moving lights.
- Two junction boxes are installed on the back wall of the stage for tour productions.
- Total connected load: max. 125A each
- Connection type: open circuit, 125A CEE coupling
- Distributed to 63A CEE and 32A CEE.
- Additional electrical connections can be provided upon request.

ICM – International Congress Center Messe München

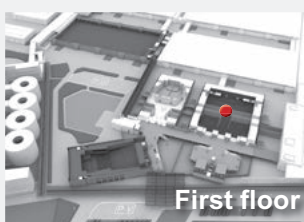
ROOM 14: EMPTY



-  Extinguisher
-  Escape route

Area in m ²
2,730

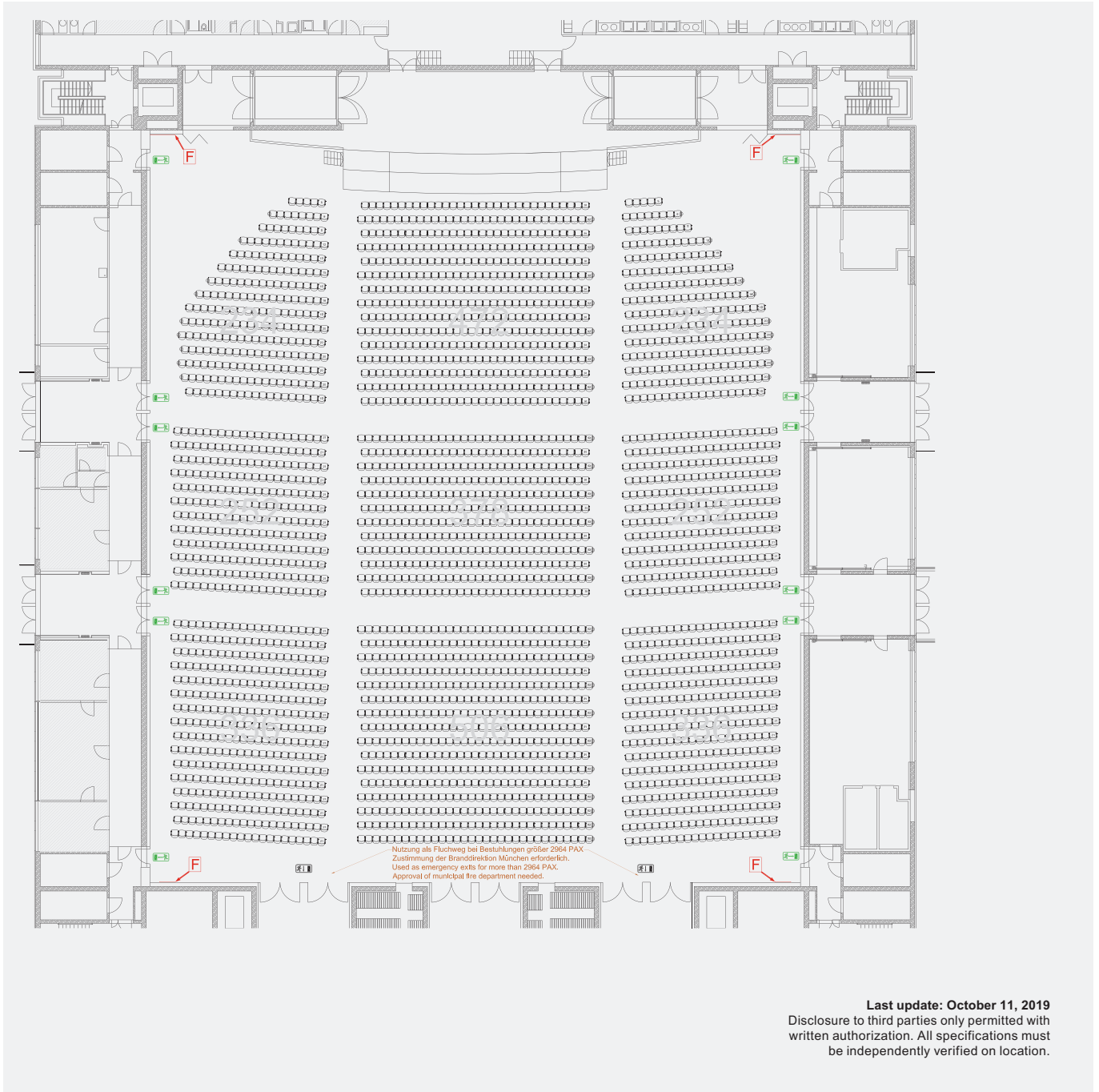

ICM – International Congress Center Messe München

ROOM 14: THEATER SEATING



Last update: October 11, 2019
Disclosure to third parties only permitted with written authorization. All specifications must be independently verified on location.



 Extinguisher
 Escape route



Area in m ²
2,730

 Theater
3,000

ICM – International Congress Center Messe München

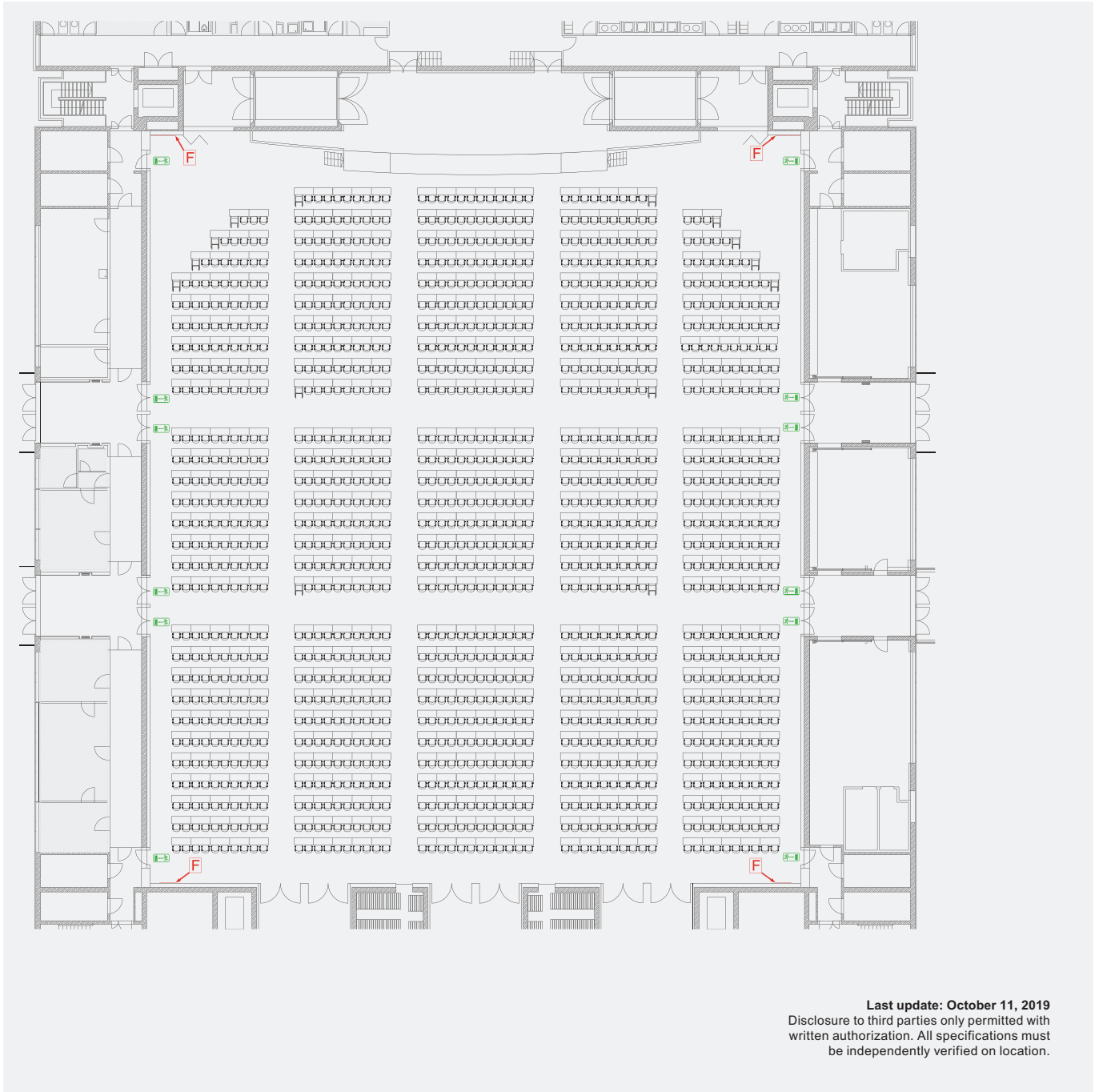
ROOM 14: CLASSROOM SEATING



 Extinguisher
 Escape route

Area in m²
2,730

 Classroom
1,464

ICM – International Congress Center Messe München

ROOM 14: BANQUET SEATING

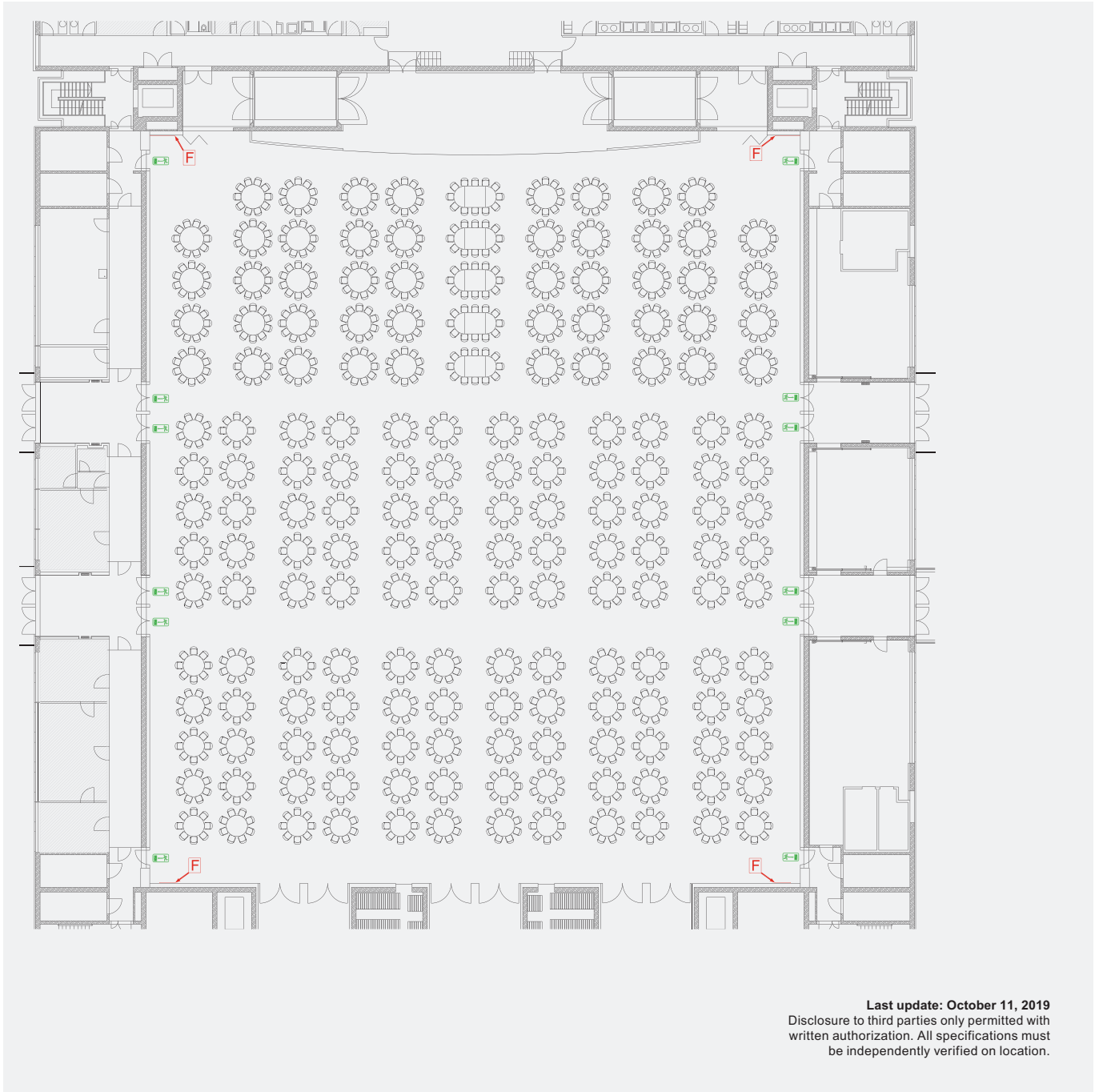

F Extinguisher
E Escape route



Area in m ²
2,730

Banquet
1,500

ICM – International Congress Center Messe München

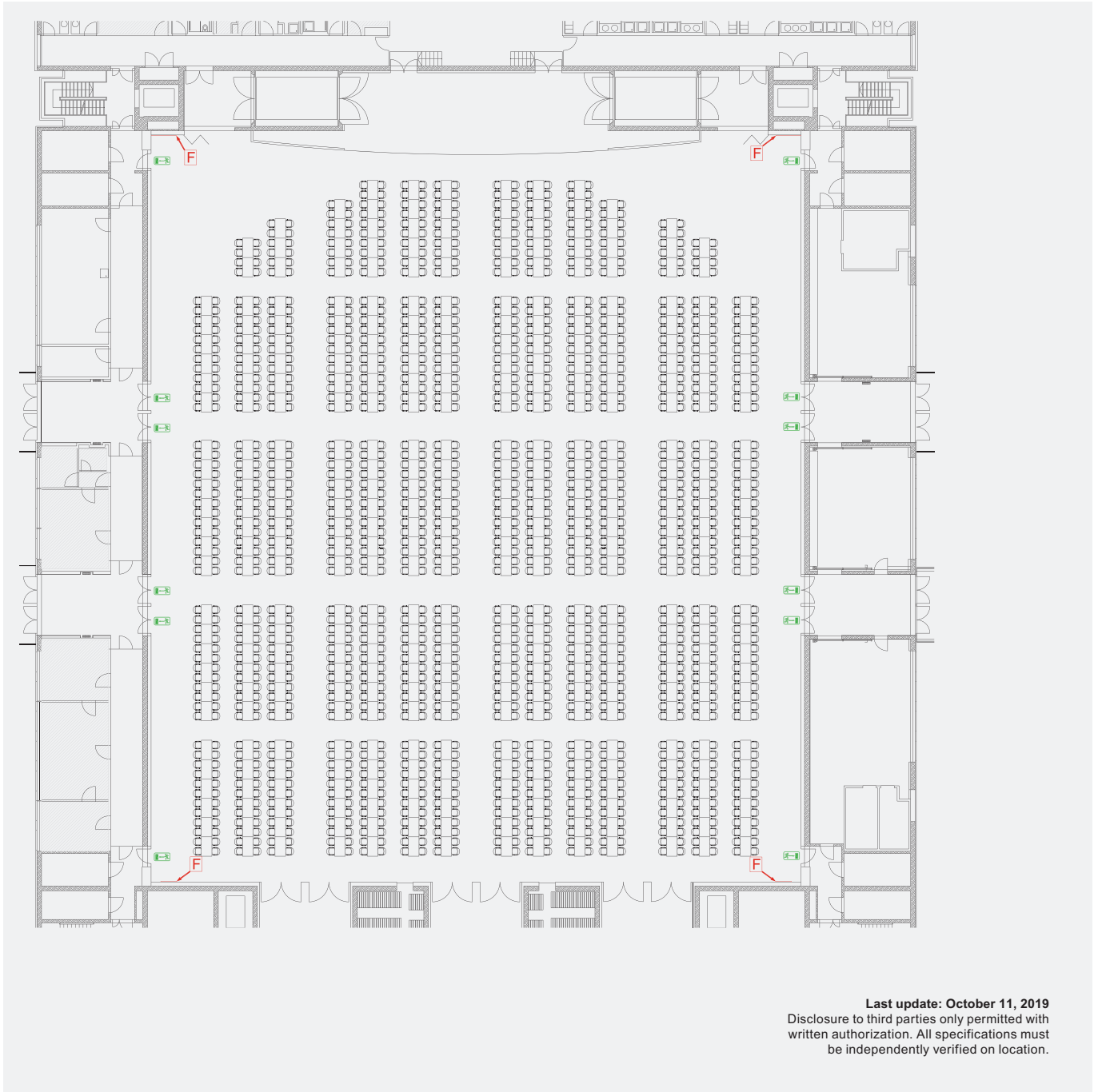
ROOM 14: BEER FEST SEATING



 Extinguisher
 Escape route



Area in m²
2,730

 Beer fest
1,592

ICM – International Congress Center Messe München

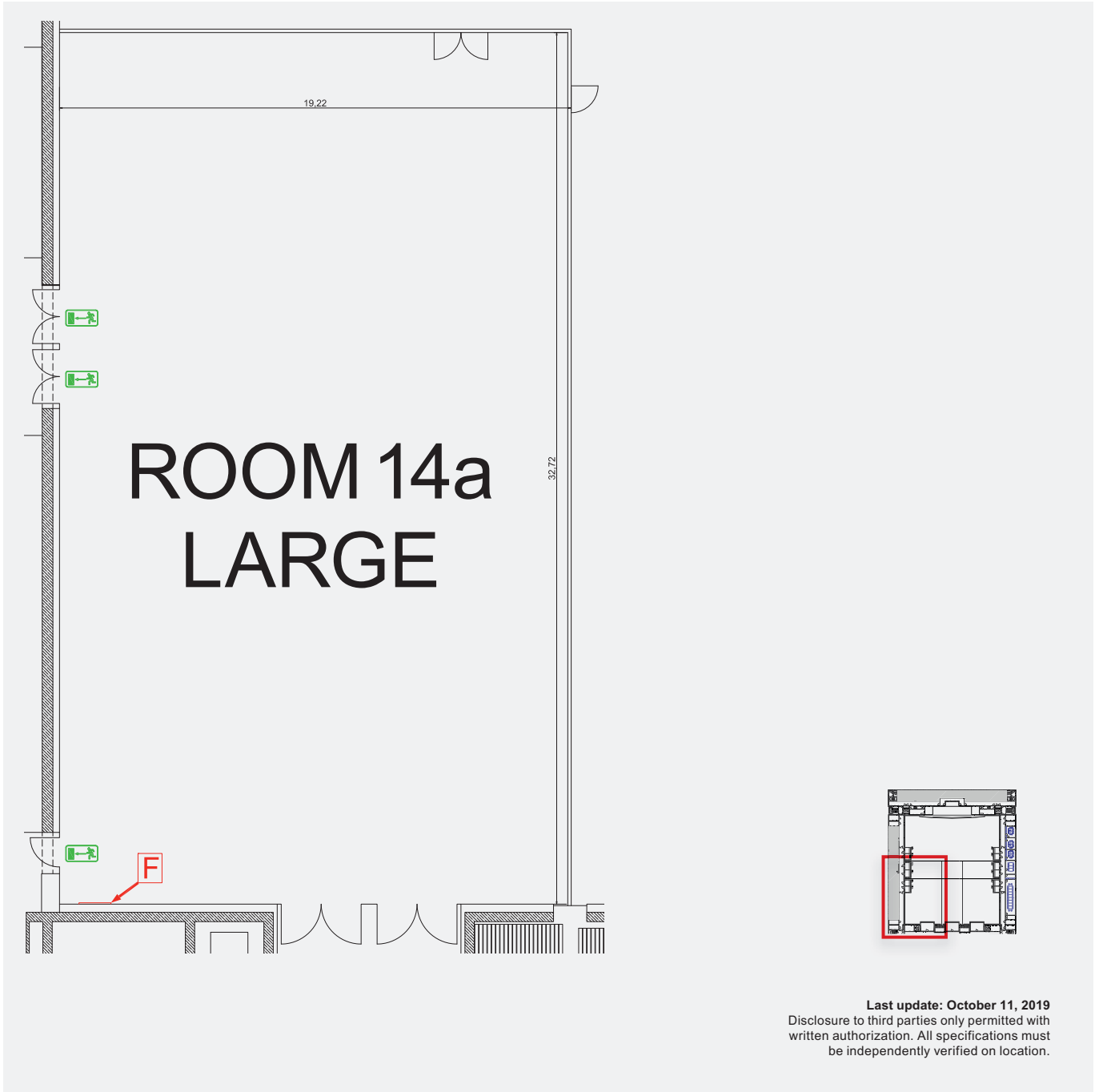
ROOM 14a LARGE: EMPTY



-  Extinguisher
-  Escape route

Area in m ²
624

ICM – International Congress Center Messe München

ROOM 14a LARGE: THEATER SEATING WITH CENTER AISLE

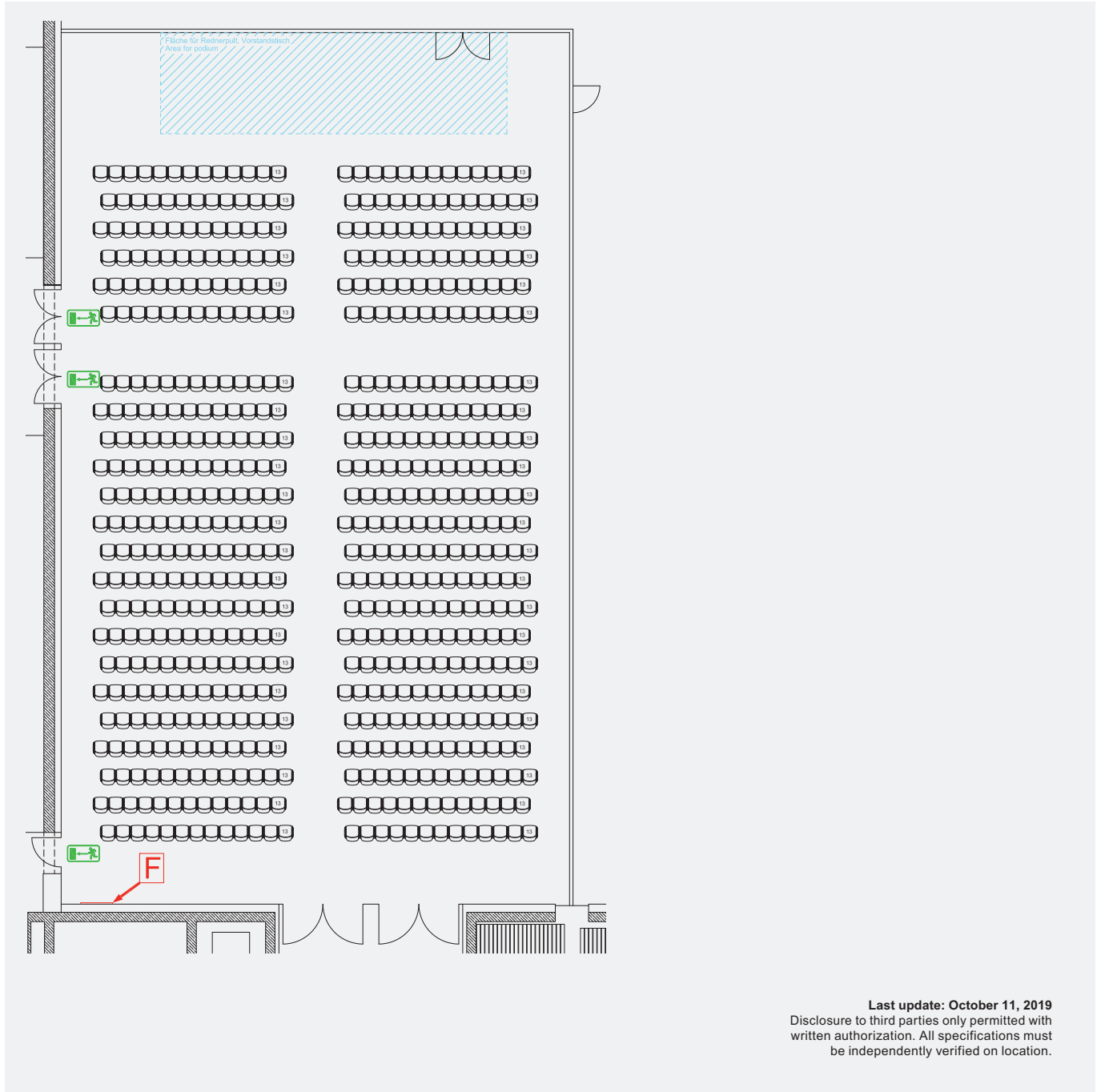

- F Extinguisher
- Escape route



Area in m ²
624

Theater
598

ICM – International Congress Center Messe München

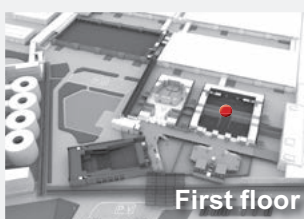
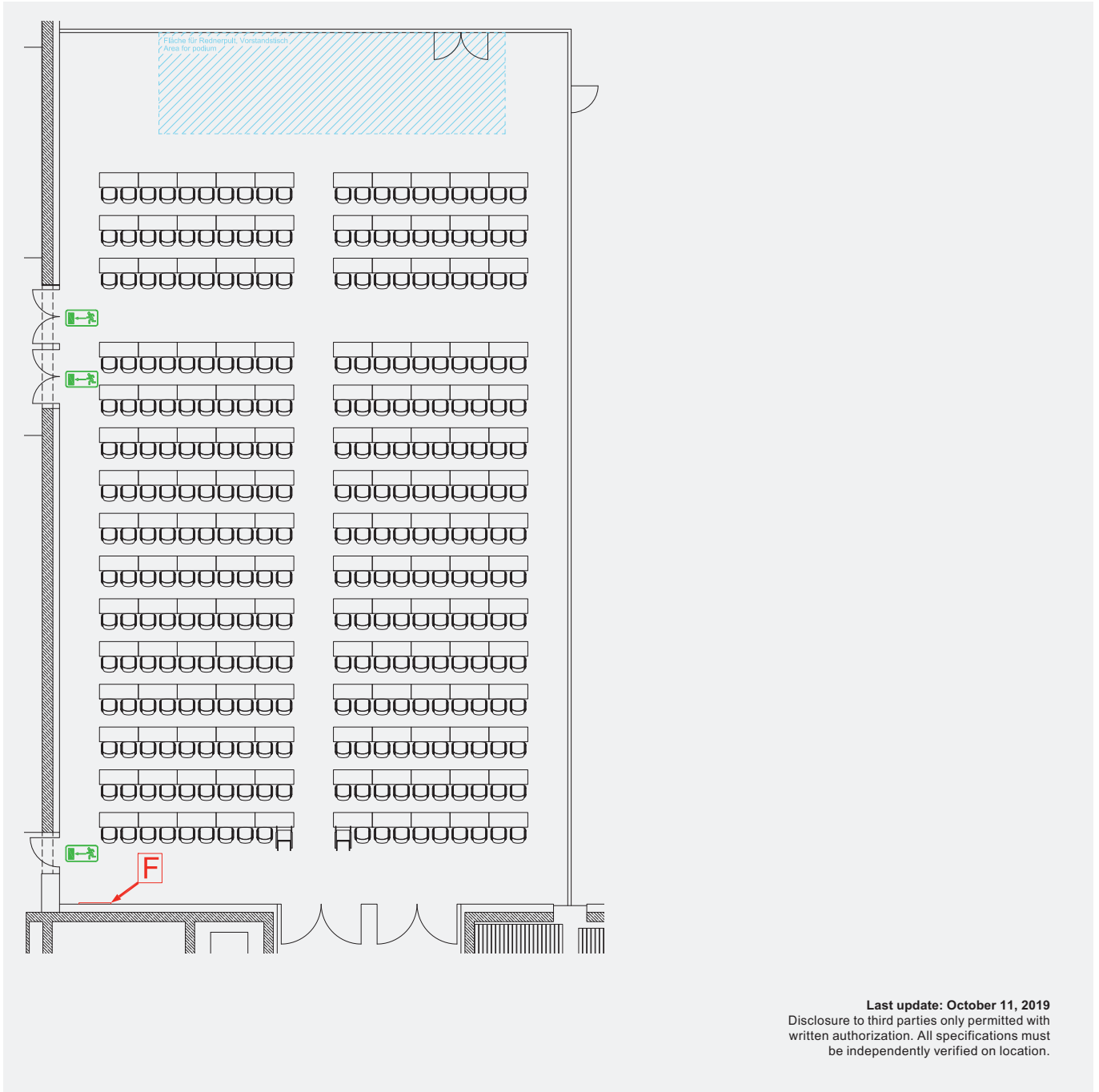
ROOM 14a LARGE: CLASSROOM SEATING



-  Extinguisher
-  Escape route

Area in m ²
624

 Classroom
300

ICM – International Congress Center Messe München

ROOM 14a LARGE: BANQUET SEATING

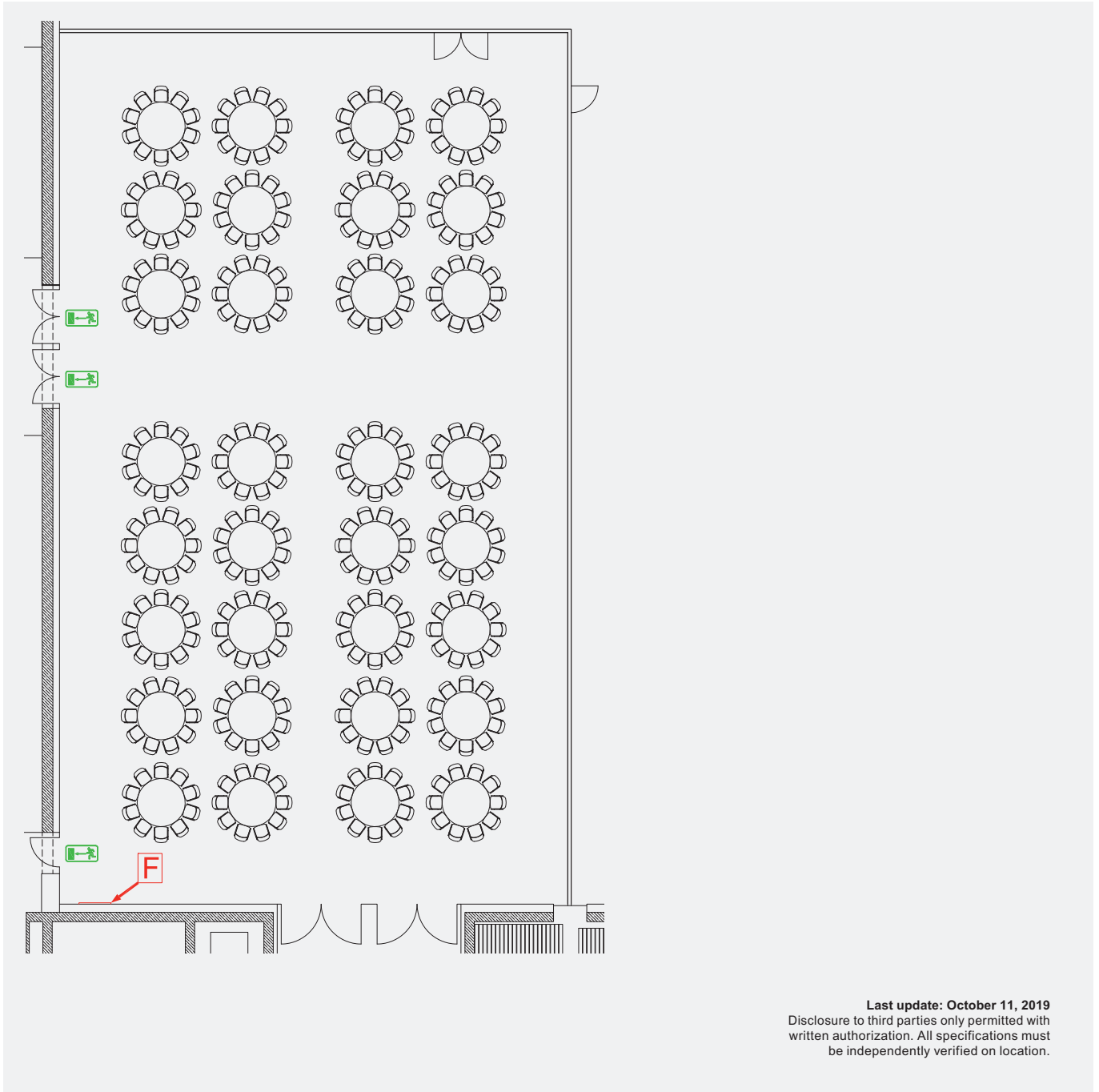

F Extinguisher
 Escape route



Area in m ²
624

 Banquet
320

ICM – International Congress Center Messe München

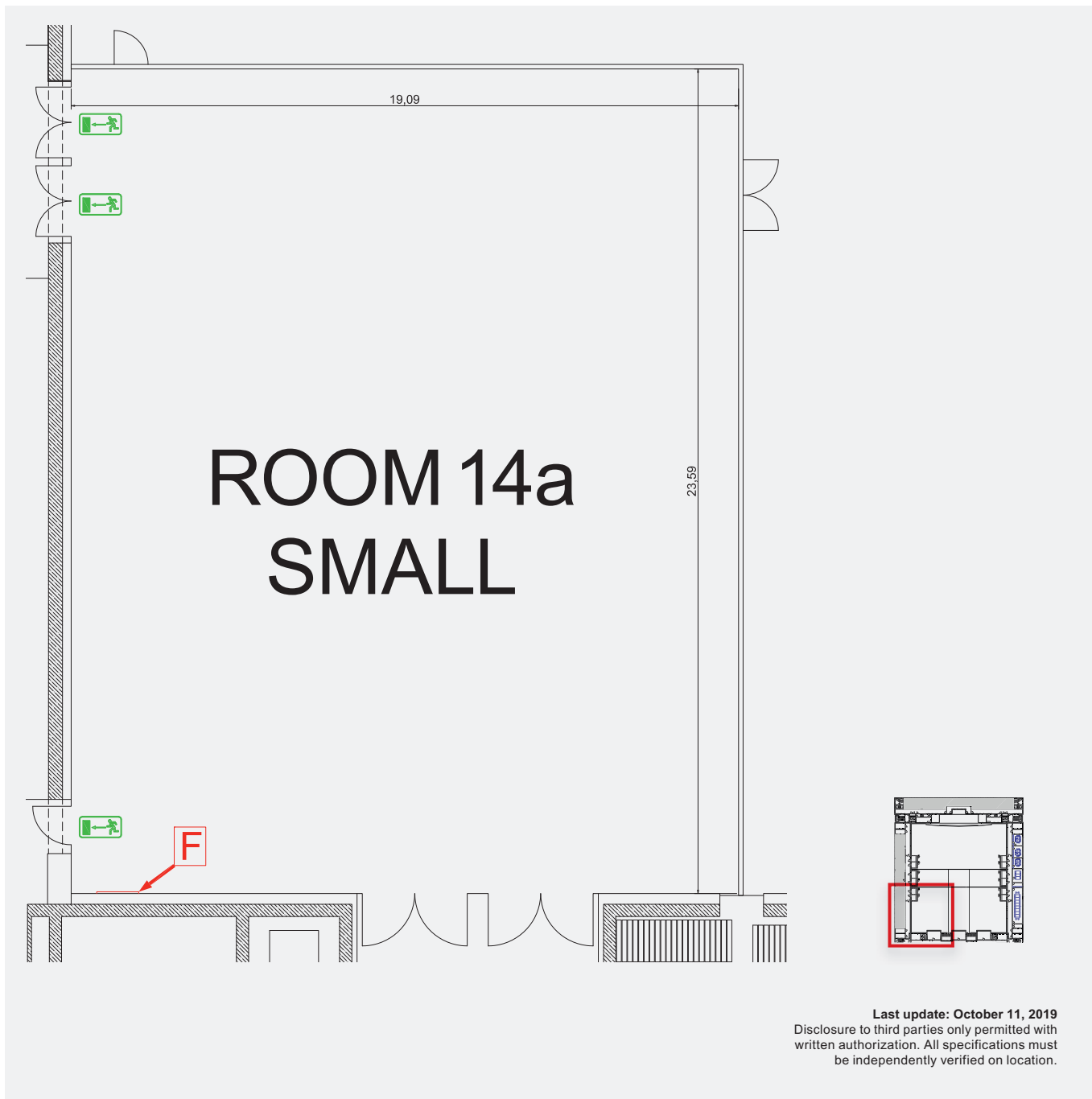
ROOM 14a SMALL: EMPTY



-  Extinguisher
-  Escape route

Area in m²

450

ICM – International Congress Center Messe München

ROOM 14a SMALL: THEATER SEATING



F Extinguisher
 Escape route

Area in m ²
450

 Theater
464

ICM – International Congress Center Messe München

ROOM 14a SMALL: CLASSROOM SEATING



Last update: October 11, 2019
Disclosure to third parties only permitted with
written authorization. All specifications must
be independently verified on location.



F Extinguisher
Escape route

Area in m²

450

Classroom

220

ICM – International Congress Center Messe München

ROOM 14a SMALL: BANQUET SEATING

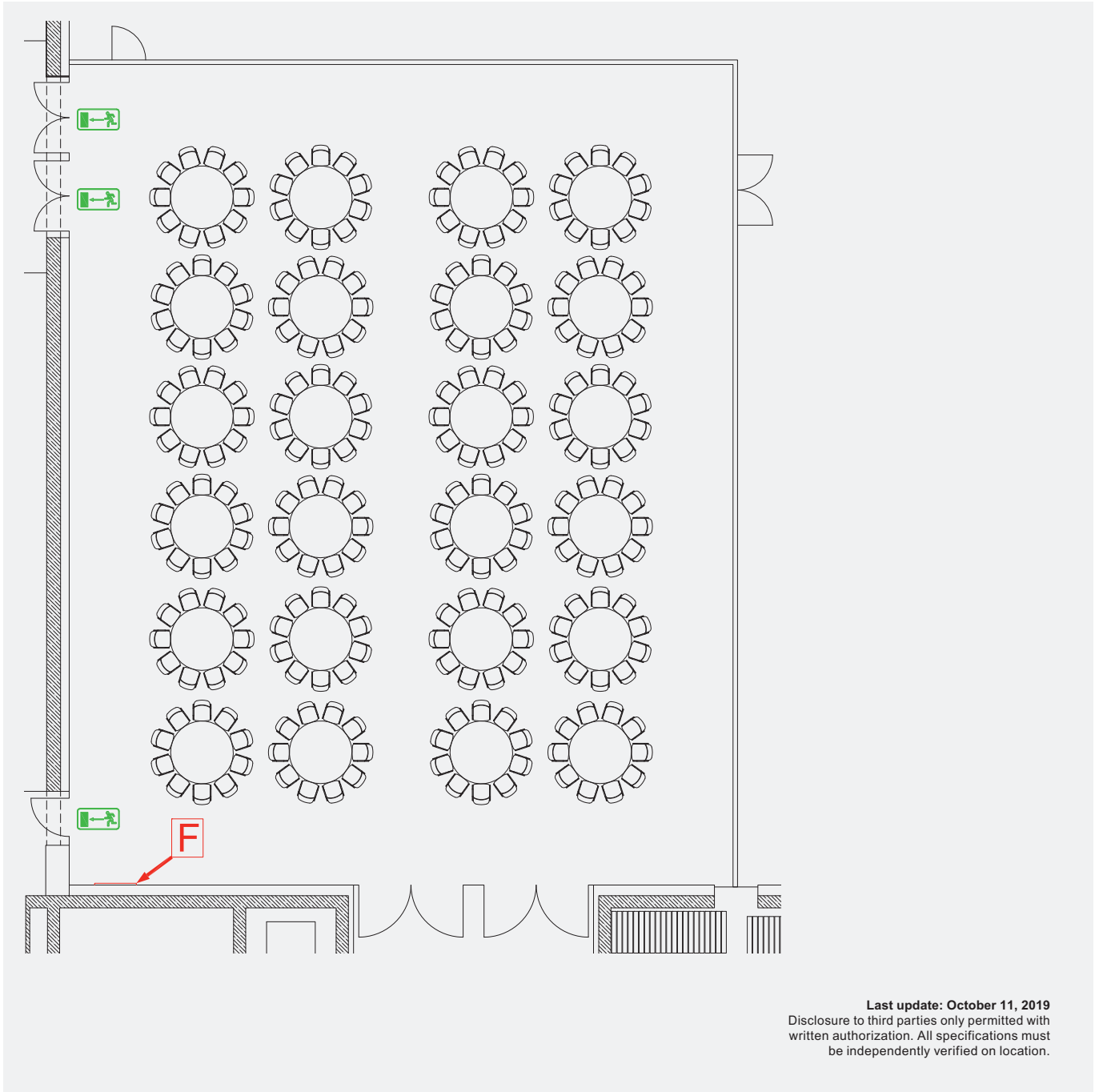

- F Extinguisher
-  Escape route

Area in m ²
450

 Banquet
240

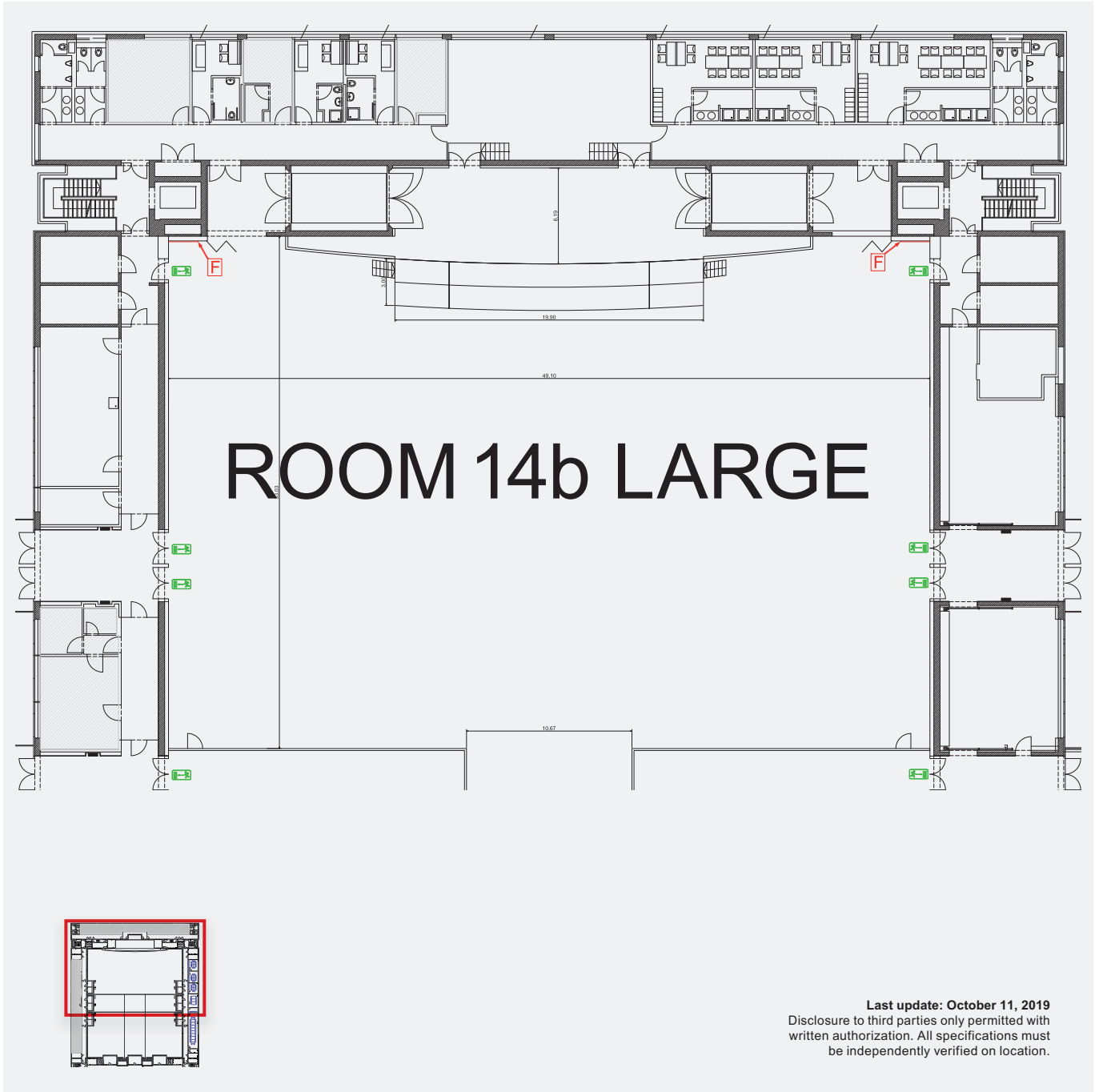

ICM – International Congress Center Messe München

ROOM 14b LARGE: EMPTY



Last update: October 11, 2019
Disclosure to third parties only permitted with
written authorization. All specifications must
be independently verified on location.



-  Extinguisher
-  Escape route

Area in m ²
1,565

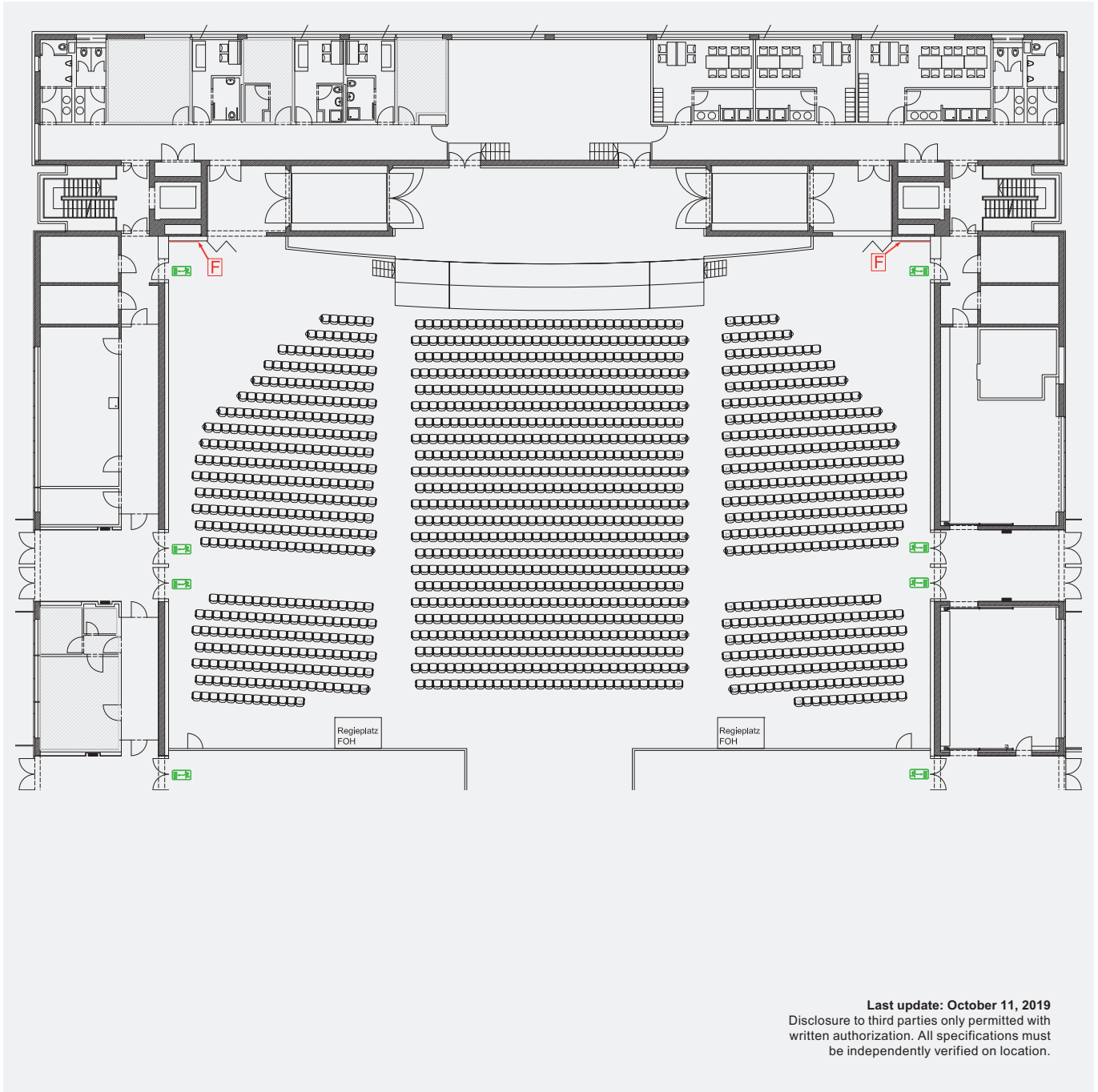

ICM – International Congress Center Messe München

ROOM 14b LARGE: THEATER SEATING

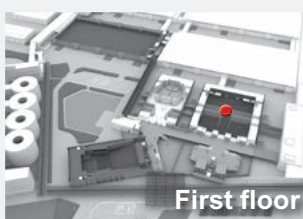

Last update: October 11, 2019
Disclosure to third parties only permitted with written authorization. All specifications must be independently verified on location.



-  Extinguisher
-  Escape route

Area in m ²
1,565

 Theater
1,482

ICM – International Congress Center Messe München

ROOM 14b LARGE: CLASSROOM SEATING

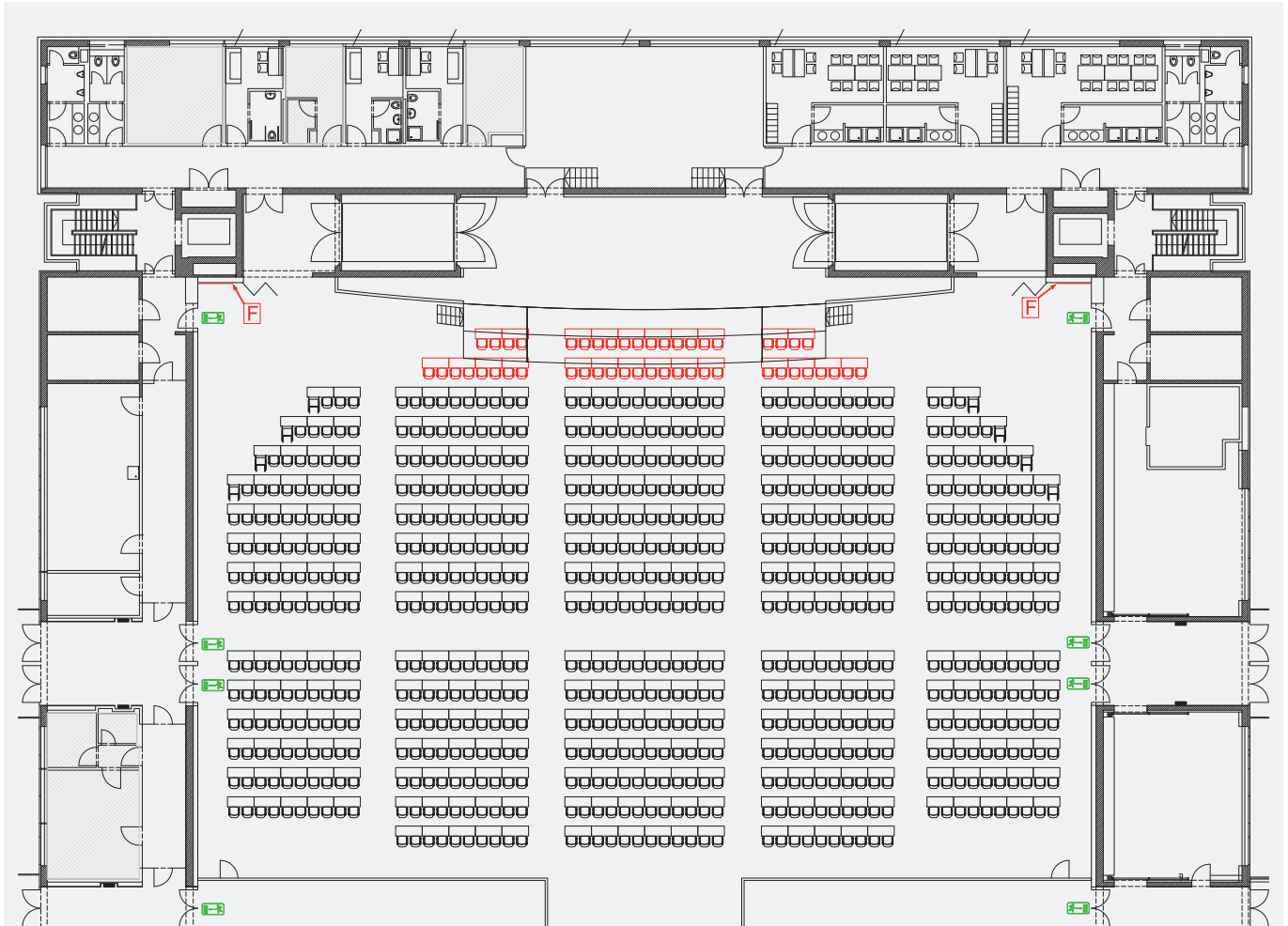

Last update: October 11, 2019
Disclosure to third parties only permitted with
written authorization. All specifications must
be independently verified on location.



F Extinguisher
→ Escape route

Area in m²

1,565

Classroom



784

736 when using
retractable platforms

ICM – International Congress Center Messe München

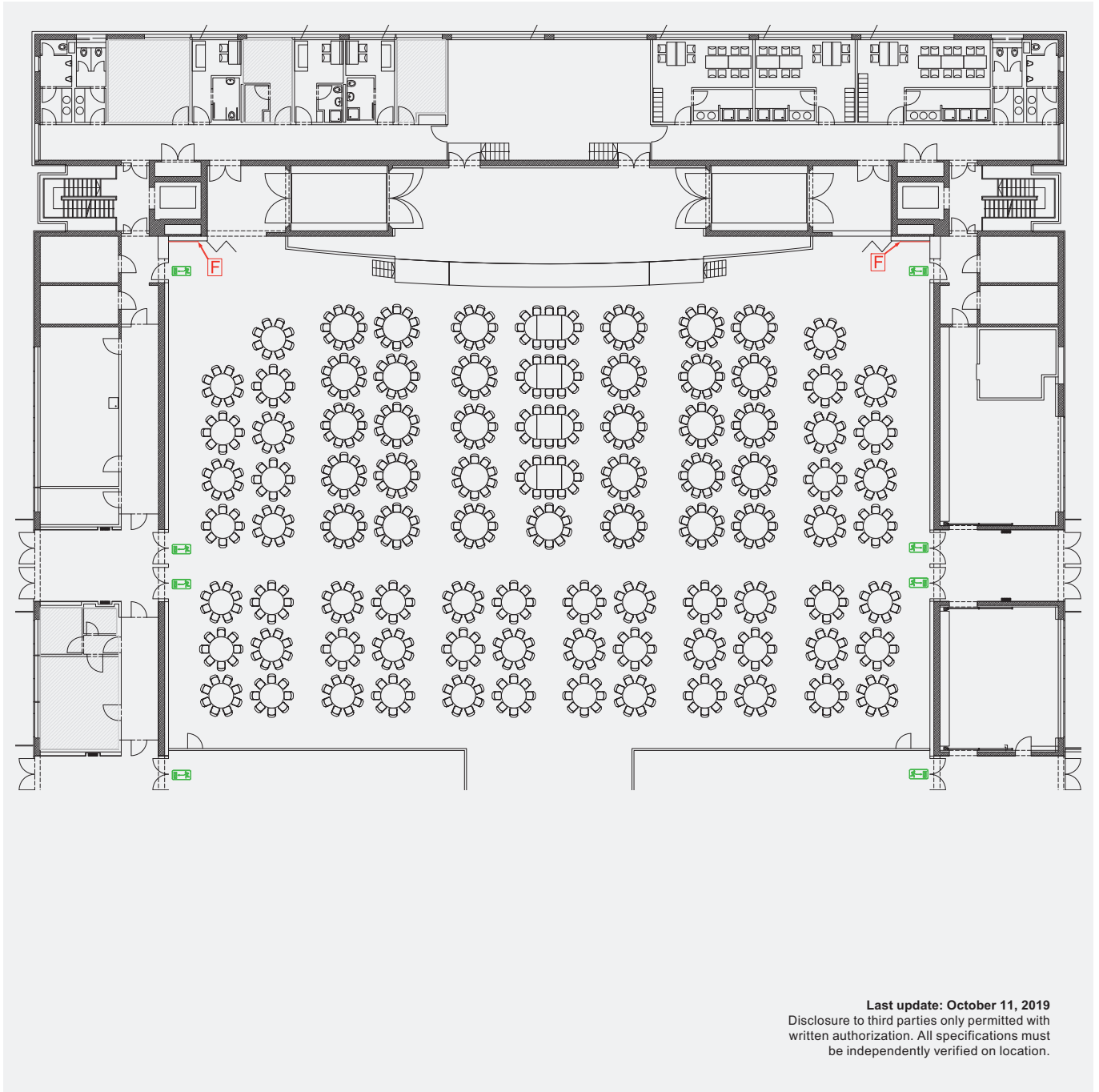
ROOM 14b LARGE: BANQUET SEATING



-  Extinguisher
-  Escape route

Area in m ²
1,565

 Banquet
826

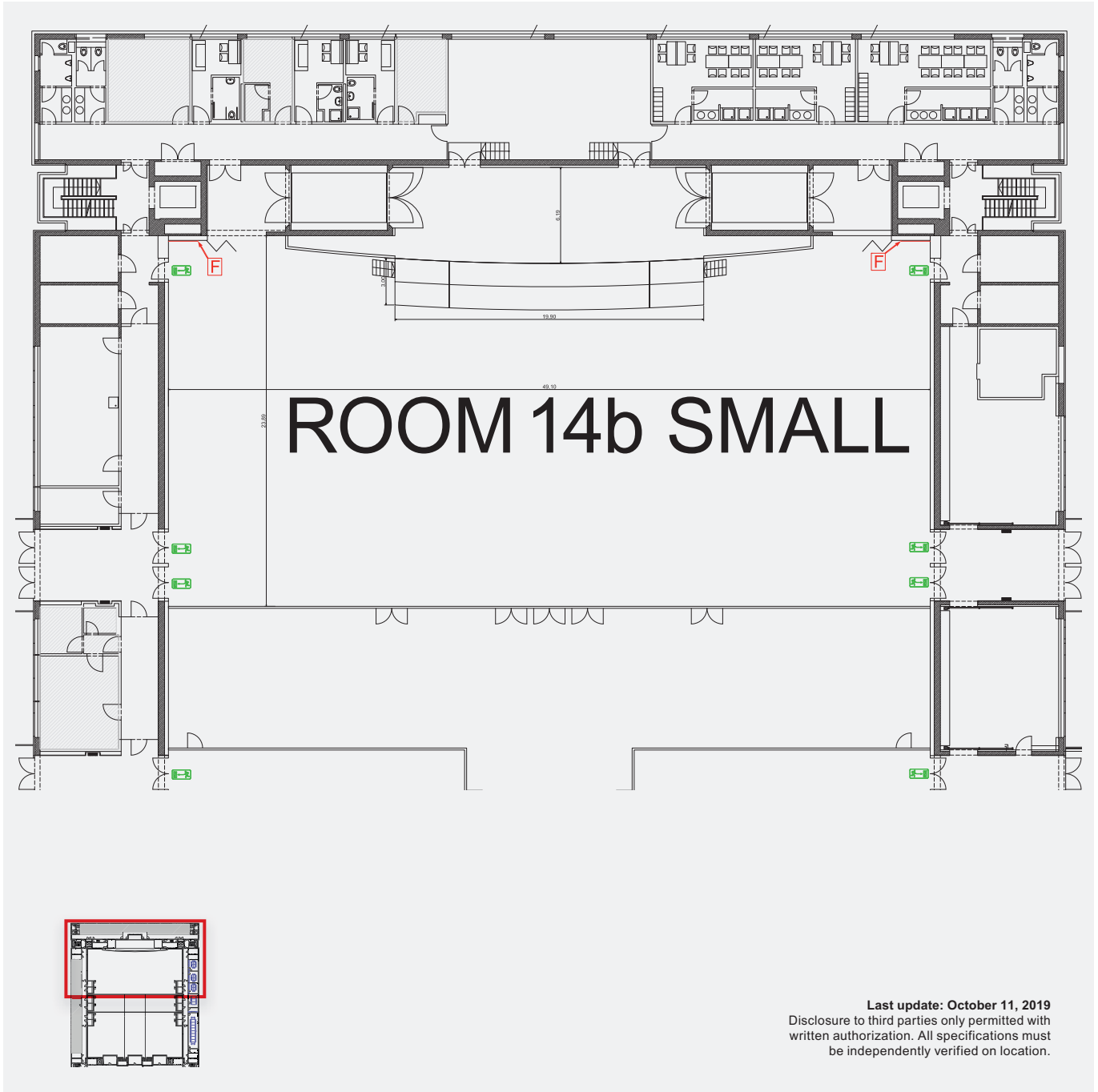

ICM – International Congress Center Messe München

ROOM 14b SMALL: EMPTY



Last update: October 11, 2019
Disclosure to third parties only permitted with
written authorization. All specifications must
be independently verified on location.



-  Extinguisher
-  Escape route

Area in m ²
1,120

ICM – International Congress Center Messe München

ROOM 14b SMALL: THEATER SEATING

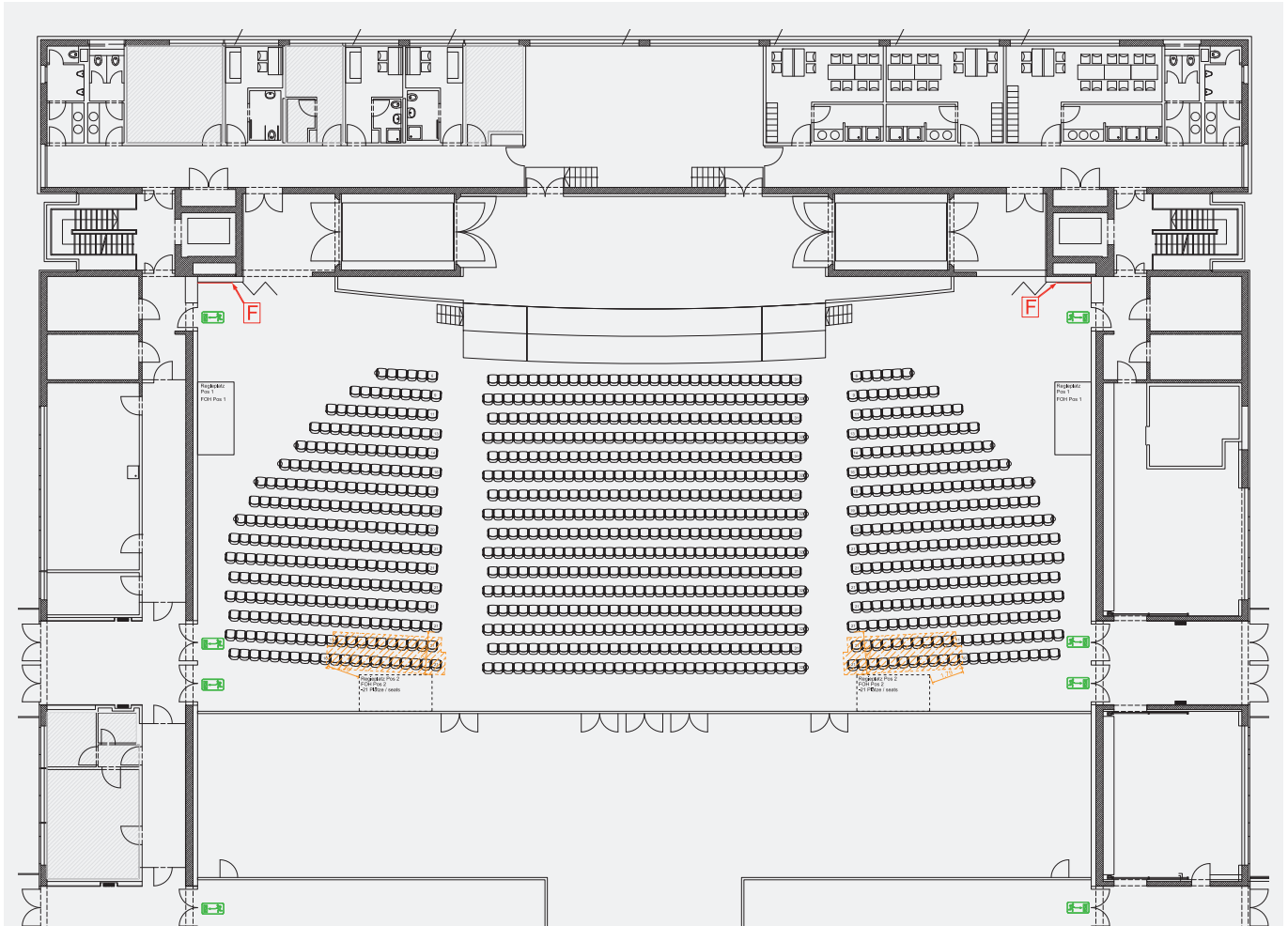

Last update: October 11, 2019
Disclosure to third parties only permitted with written authorization. All specifications must be independently verified on location.

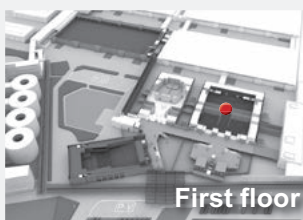

F Extinguisher
→ Escape route

Area in m ²
1,120

 Theater
1,050

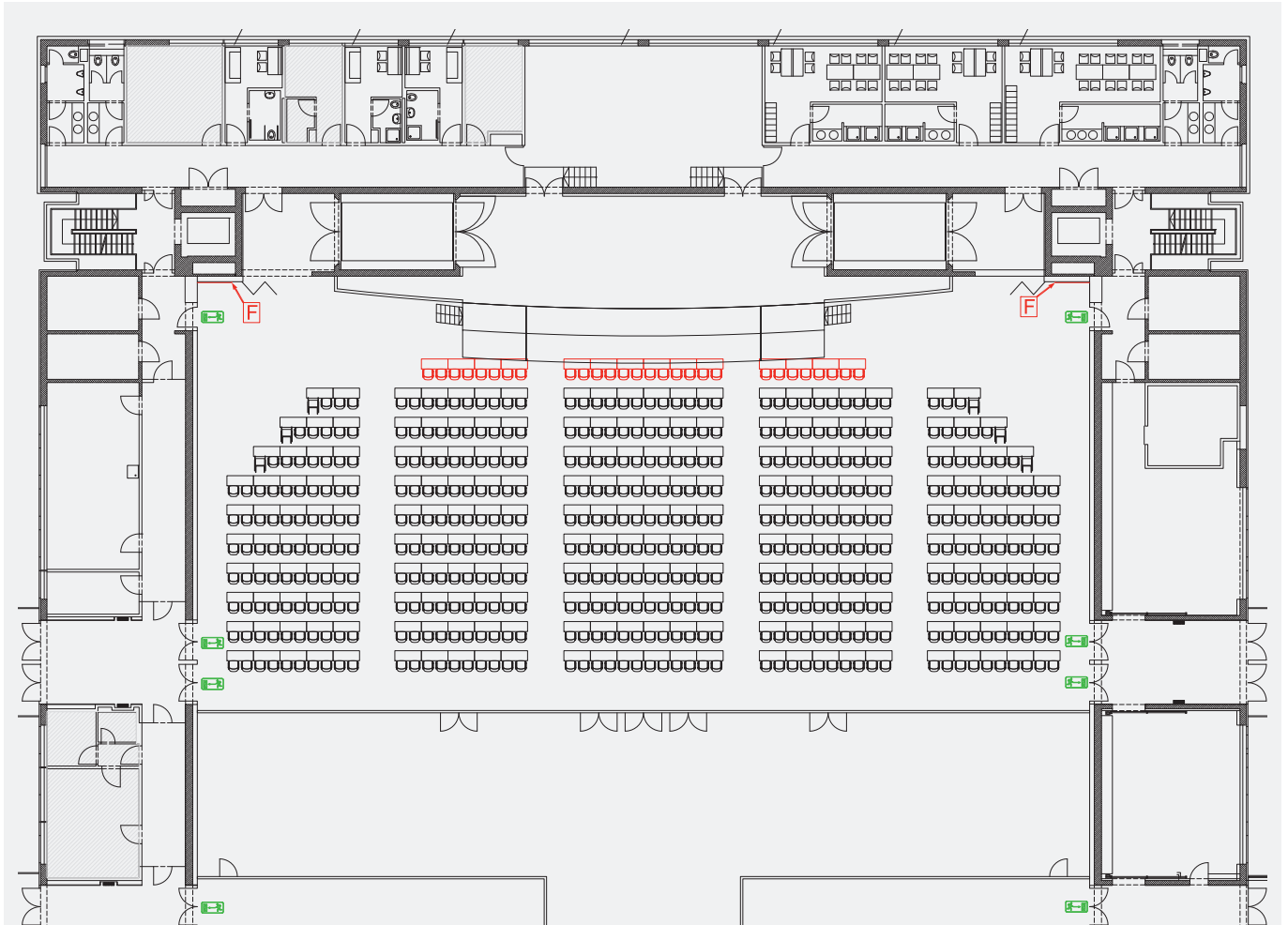

ICM – International Congress Center Messe München

ROOM 14b SMALL: CLASSROOM SEATING



Last update: October 11, 2019
Disclosure to third parties only permitted with
written authorization. All specifications must
be independently verified on location.



-  Extinguisher
-  Escape route

Area in m²

1,120

 Classroom

524

496 when using
retractable platforms

ICM – International Congress Center Messe München

SAAL 14b SMALL: BANQUET SEATING

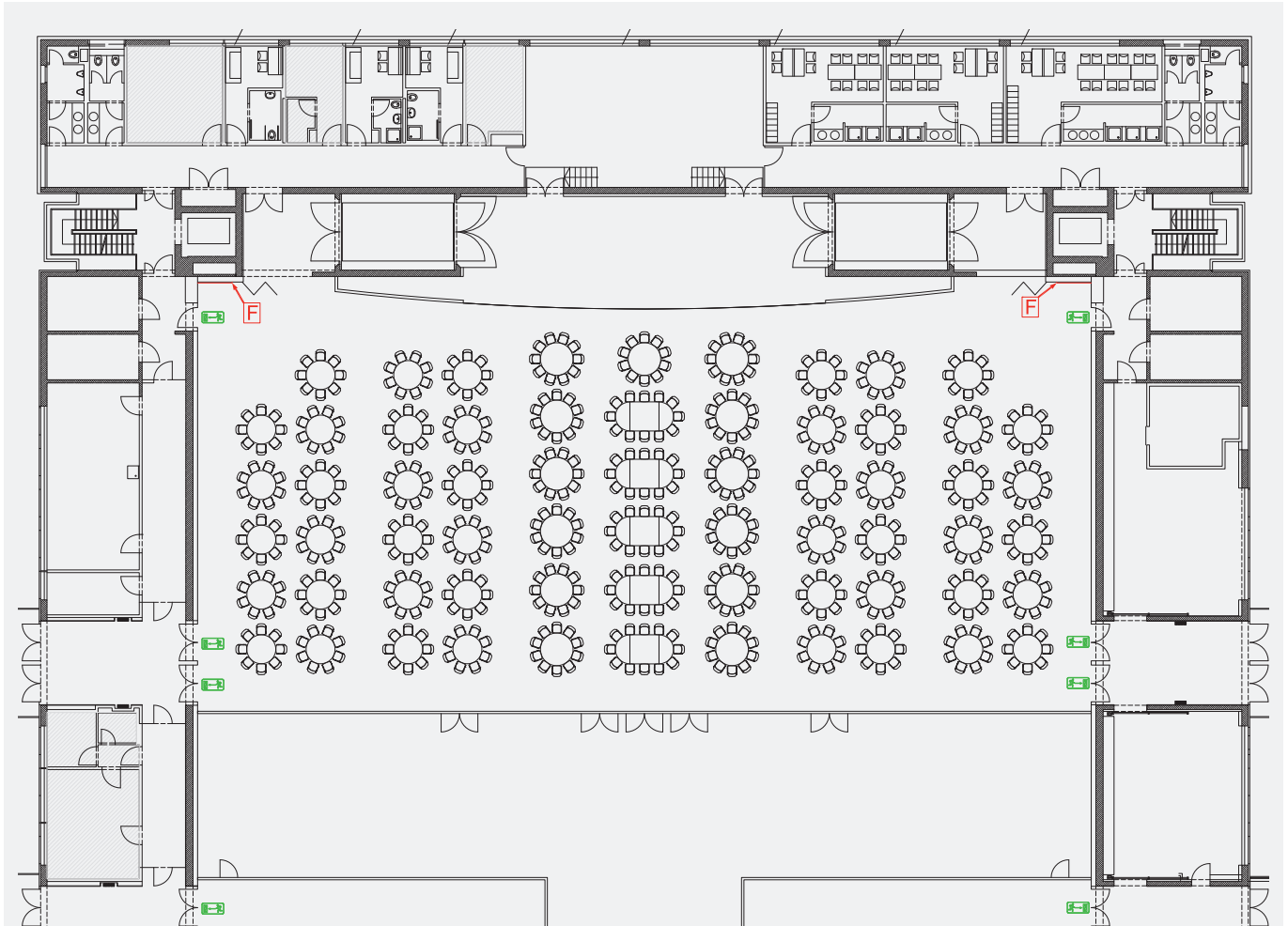

Last update: October 11, 2019
Disclosure to third parties only permitted with written authorization. All specifications must be independently verified on location.

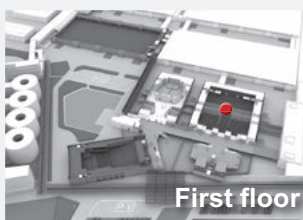

- F Extinguisher
- ➔ Escape route



Area in m ²
1,120

Banquet
558

ICM – International Congress Center Messe München

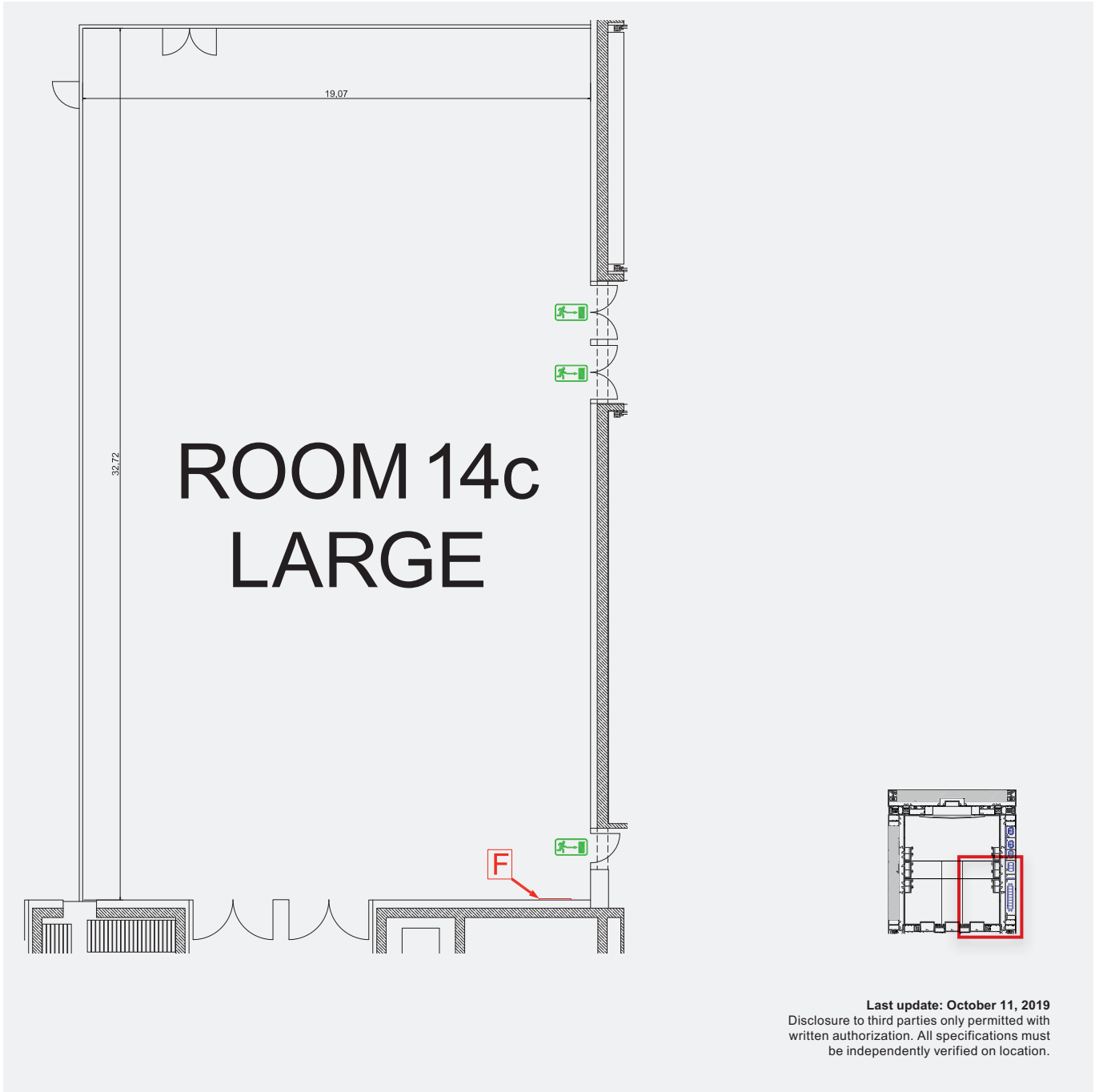
ROOM 14c LARGE: EMPTY



-  Extinguisher
-  Escape route

Area in m ²
624

ICM – International Congress Center Messe München

ROOM 14c LARGE: THEATER SEATING WITH CENTER AISLE



Last update: October 11, 2019
 Disclosure to third parties only permitted with written authorization. All specifications must be independently verified on location.



F Extinguisher
→ Escape route

Area in m²
 624

Theater
 598

ICM – International Congress Center Messe München

ROOM 14c LARGE: CLASSROOM SEATING

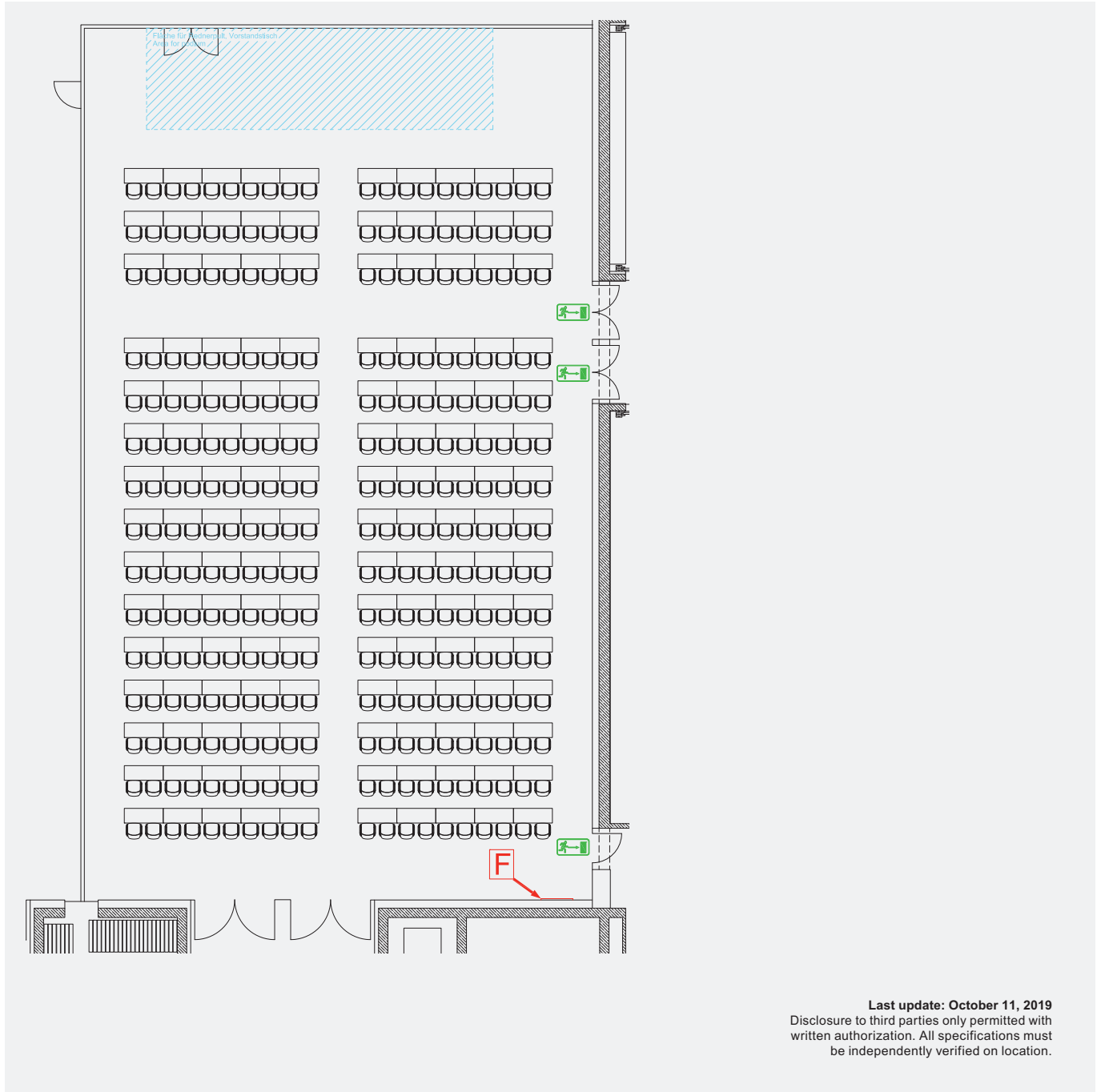

Last update: October 11, 2019
Disclosure to third parties only permitted with written authorization. All specifications must be independently verified on location.



F Extinguisher
→ Escape route

Area in m²
624

Classroom
300

ICM – International Congress Center Messe München

ROOM 14c LARGE: BANQUET SEATING

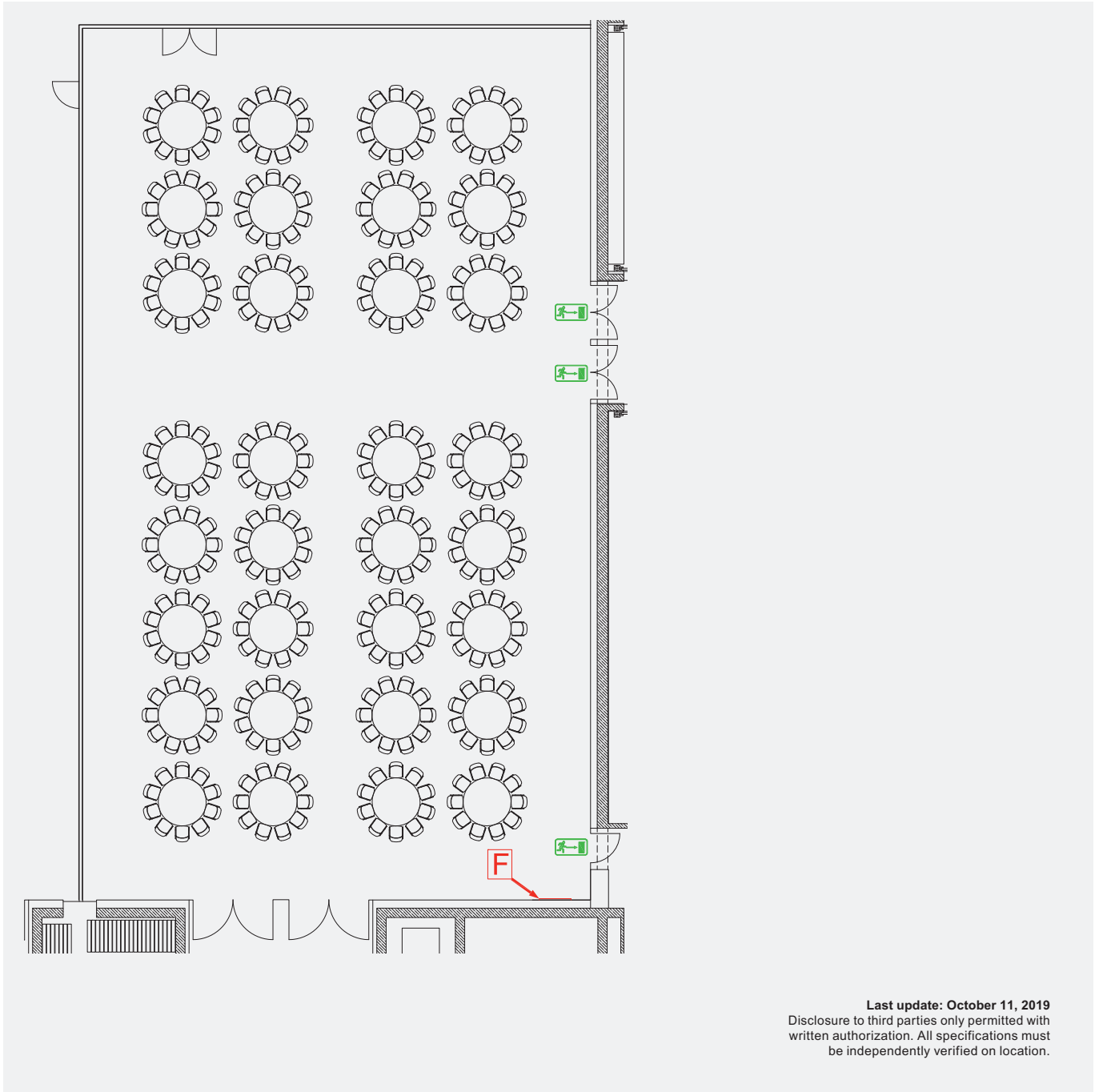

Last update: October 11, 2019
Disclosure to third parties only permitted with written authorization. All specifications must be independently verified on location.



F Extinguisher
 Escape route



Area in m ²
624

 Banquet
320

ICM – International Congress Center Messe München

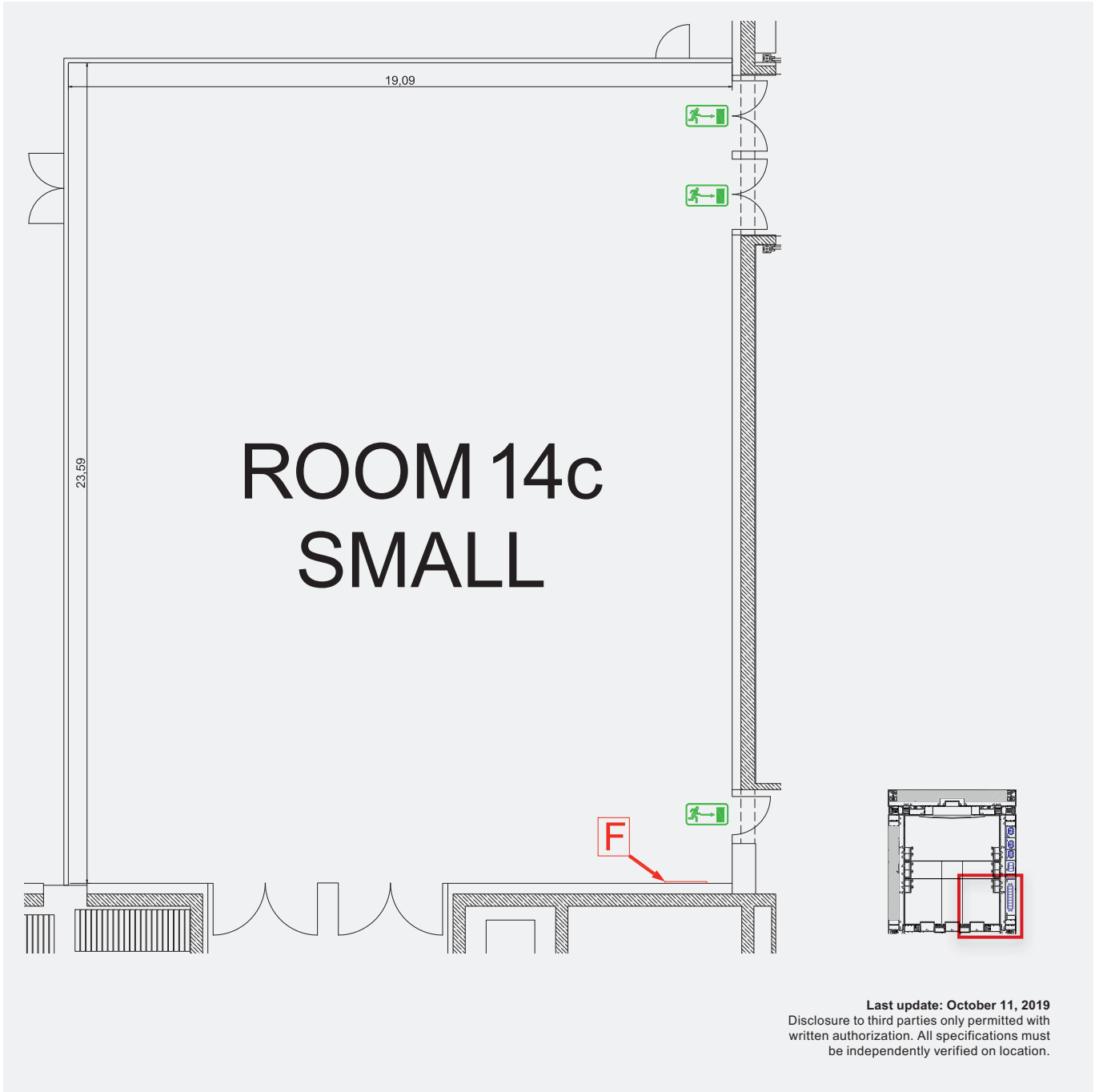
ROOM 14c SMALL: EMPTY



-  Extinguisher
-  Escape route

Area in m ²
450

ICM – International Congress Center Messe München

ROOM 14c SMALL: THEATER SEATING

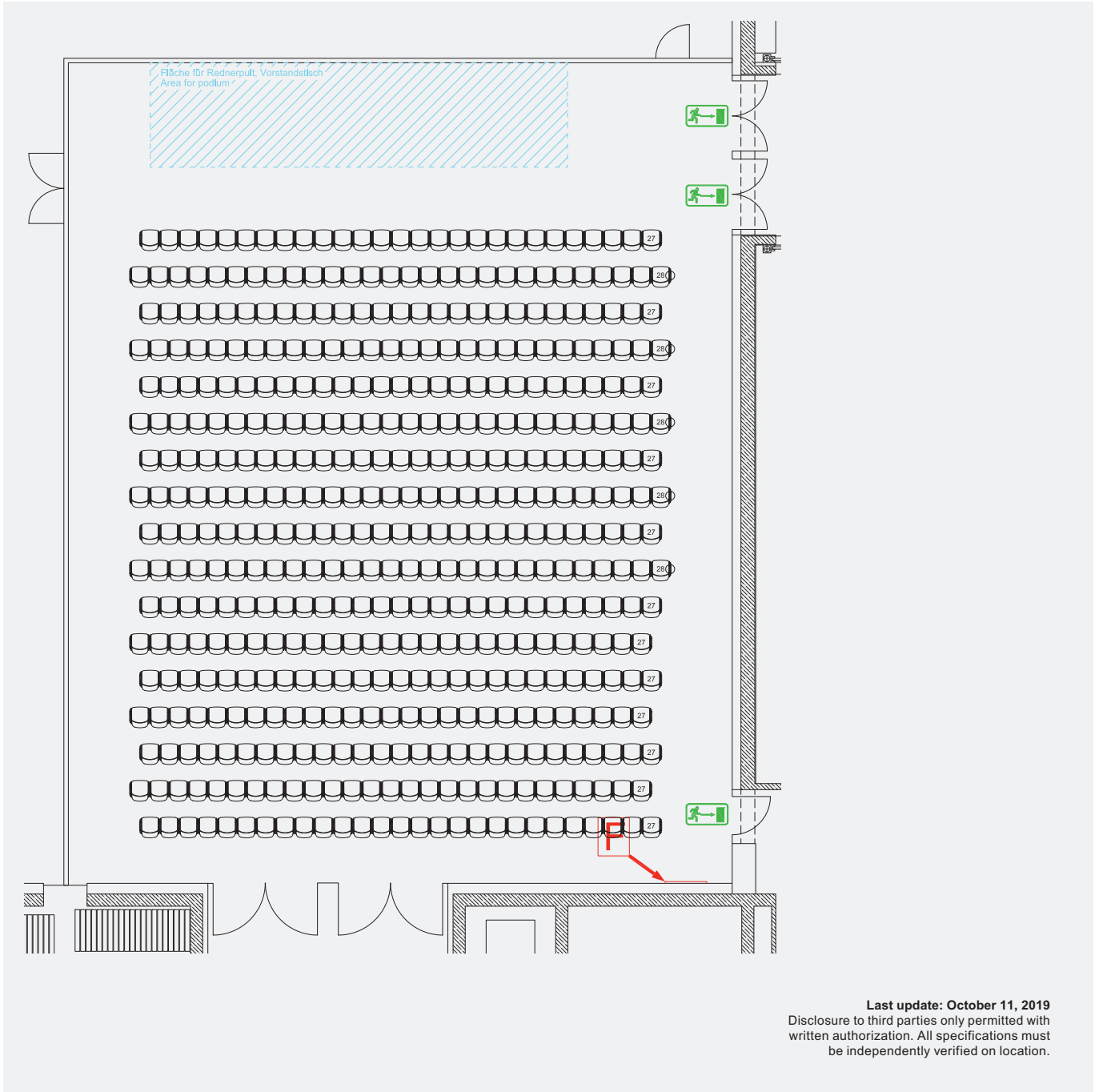

F Extinguisher
→ Escape route

Area in m ²
450

Theater
464

ICM – International Congress Center Messe München

ROOM 14c SMALL: CLASSROOM SEATING



Last update: October 11, 2019
Disclosure to third parties only permitted with
written authorization. All specifications must
be independently verified on location.

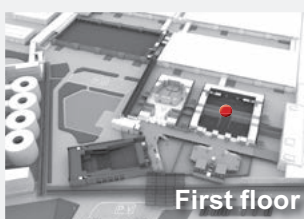

F Extinguisher
 Escape route

Area in m ²
450

 Classroom
220

ICM – International Congress Center Messe München

ROOM 14c SMALL: BANQUET SEATING

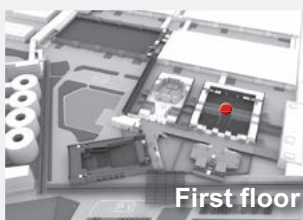
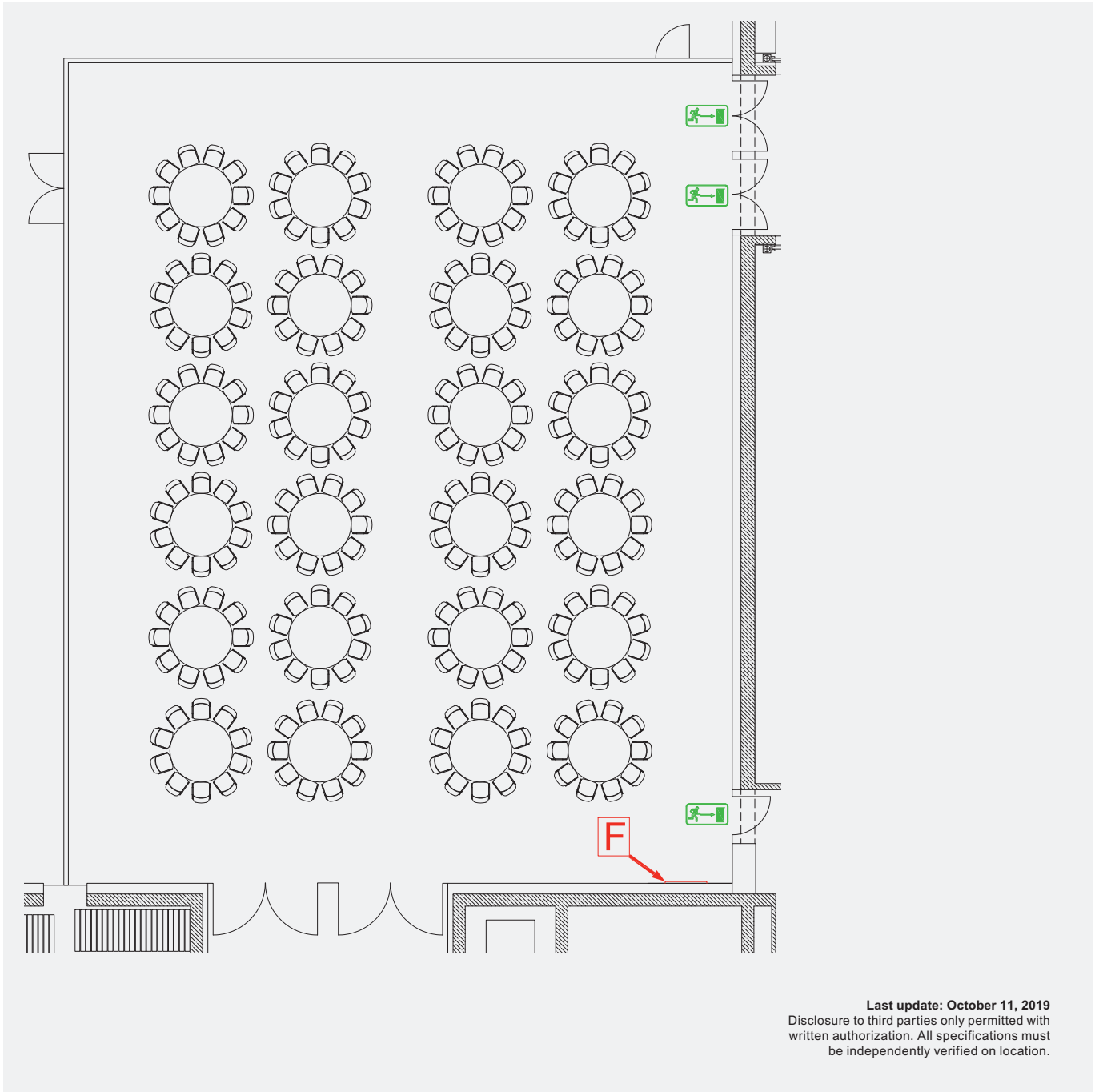

F Extinguisher
 Escape route

Area in m²
450

 Banquet
240

ROOM 14: PERFORMER DRESSING ROOMS

1.126	1.130	1.132	1.135
private performer dressing room single 12 m ²	private performer dressing room single 13 m ²	private performer dressing room single 11 m ²	Backstage 92 m ²

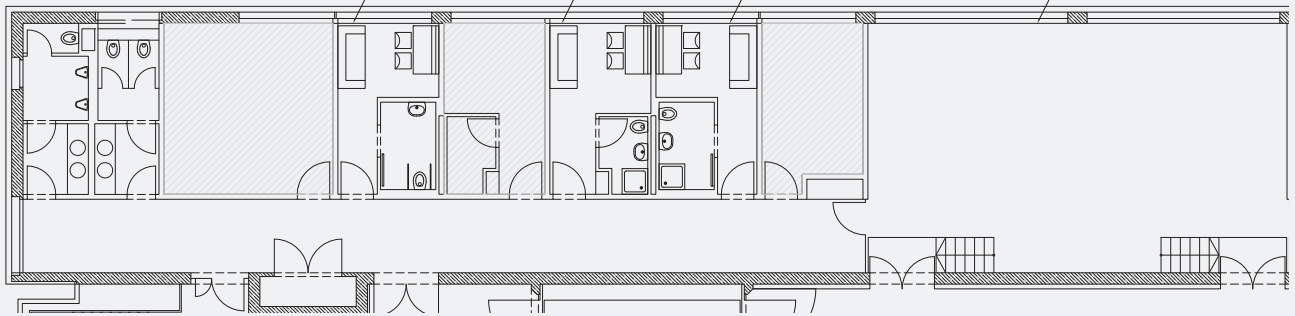

1.135	1.140	1.142	1.144
Backstage 92 m ²	group performer dressing room 26 m ²	group performer dressing room 26 m ²	group performer dressing room 34 m ²

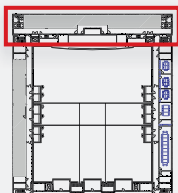
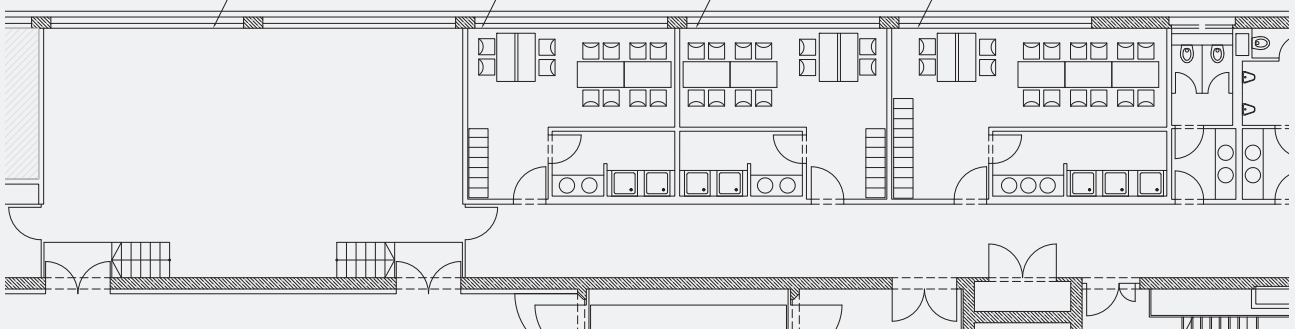

Last update: October 11, 2019
Disclosure to third parties only permitted with
written authorization. All specifications must
be independently verified on location.

ICM – International Congress Center Messe München

ROOM 14: INTERPRETER'S BOOTHS

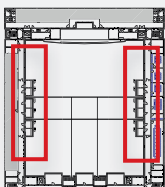
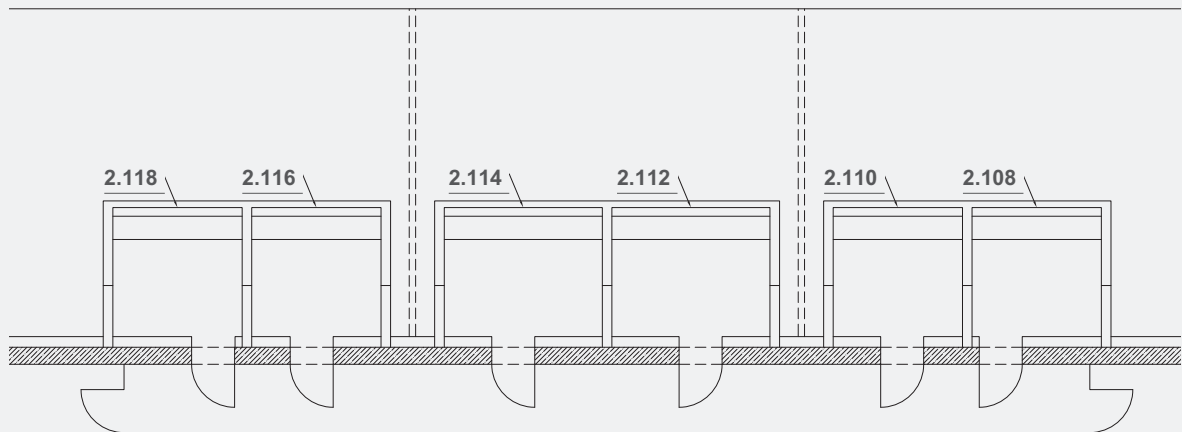
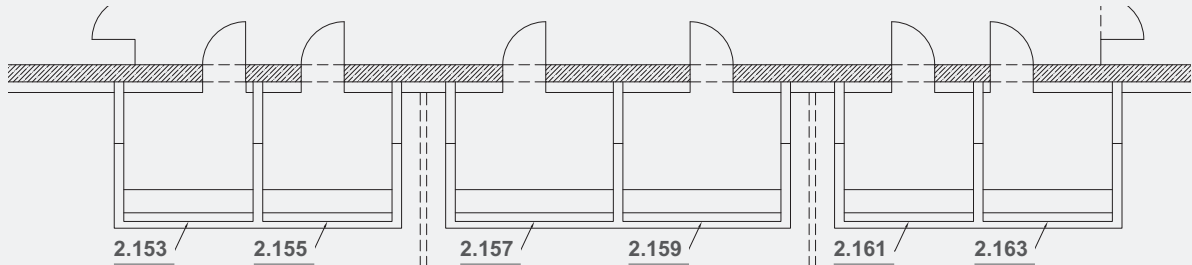

Last update: October 11, 2019
Disclosure to third parties only permitted with
written authorization. All specifications must
be independently verified on location.