

chemollifire.com



CHEMOLLI FIRE®
engineering and testing since ever

Accessori
HARDWARE



CHEMOLLI FIRE®

engineering and testing since ever

**PROGETTAZIONE, TESTING
E CERTIFICAZIONE
DI PORTE TAGLIAFUOCO**

Consulenti internazionali, per migliorare i
tuoi sistemi tagliafuoco e renderli più sicuri

**ENGINEERING, TESTING
AND CERTIFICATION
OF FIRE RESISTANT DOORS**

International advisors, improving your fire
resistant systems and making them safer

chemollifire.com

CHEMOLLI FIREBOLT A1



(R38064)



ROUNDED, STANDARD VERSION

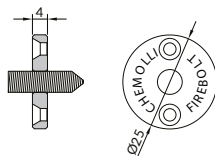

MILLED VERSION

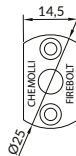

Rostro passivo regolabile

Rostro di tenuta per chiusure resistenti al fuoco e/o antieffrazione atto a evitare lo sfilamento dell'anta dal lato delle cerniere.

Inactive adjustable bolt

Mechanical seal bolt for fire resistant and/ or security doors to avoid the possibility to extract the door leaf from the fixed frame on the hinges side.



Finiture / Finishes: ■ nichelato / nickel ■ verniciato / painted RAL- NCS

CHEMOLLI FIREBOLT A2.0



(R38064)



ROUNDED, STANDARD VERSION

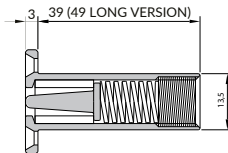

MILLED VERSION

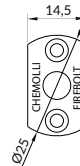

Rostro attivo

Rostro attivo per chiusure tagliafuoco atto a eliminare la deformazione del punto in cui è installato, tra anta e telaio, anta e anta, anta e supporto.

Active bolt

Active bolt for fire resistant doors is designed to avoid deflection where it is positioned, between door leaf and frame, door leaf and door leaf, door leaf and support.



Finiture / Finishes: ■ nichelato / nickel ■ verniciato / painted RAL- NCS

CHEMOLLI FIREBOLT A5

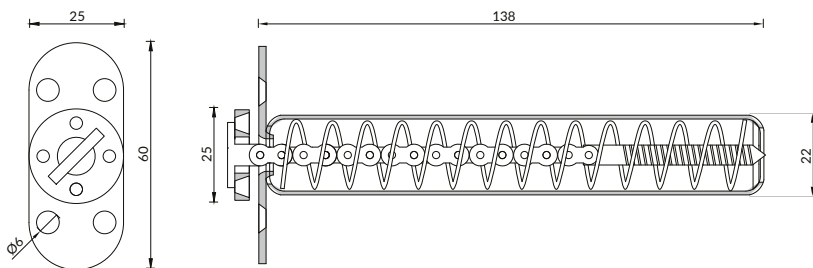

Chiudiporta tubolare a scomparsa

Chiudiporta tubolare a scomparsa, lunghezza tubolare 138 mm, molla interna precaricata con forza 15-25 N.

Tubular concealed door closer

Tubular concealed door closer, tube length 138 mm, internal spring preloaded with force 15-25 N.



Finiture / Finishes: ■ SS + Zinc plated

CHEMOLLI FIREBOLT A5.1

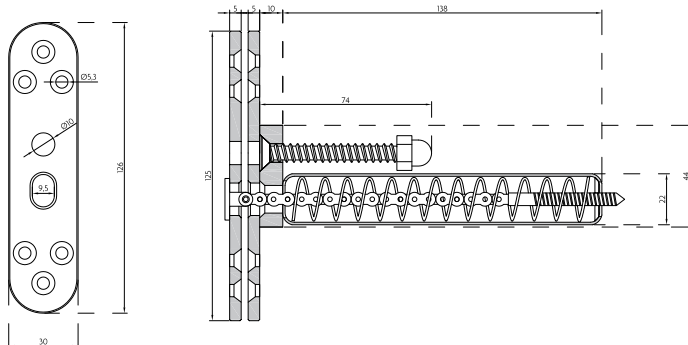

Chiudiporta tubolare a scomparsa regolabile

Chiudiporta tubolare a scomparsa, lunghezza tubolare 138 mm, molla interna precaricata con forza 15-25 N.

Adjustable tubular concealed door closer

Tubular concealed door closer, tube length 138 mm, internal spring preloaded with a 15-25 N strength.



Finiture / Finishes: ■ SS + Zinc plated

CHEMOLLI FIREBOLT A6

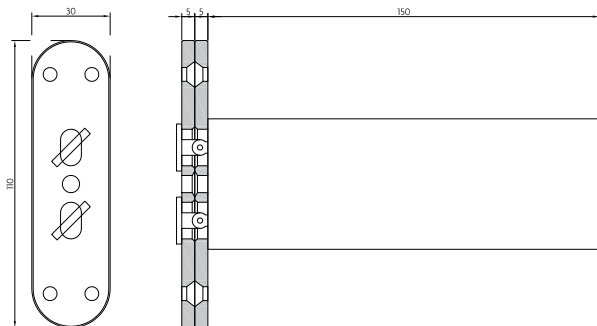

Chiudiporta tubolare a scomparsa regolabile

Chiudiporta tubolare a scomparsa regolabile, lunghezza corpo 150 mm, doppia molla interna precaricata, cadauna con forza 15-25N. Regolabile senza smontaggio della piastra a telaio.

Tubular concealed door closer, adjustable

Tubular concealed door closer, adjustable, body length 150 mm, double internal spring, preloaded with a force of 15-15N each. Adjustable without dismantling the frame plate.



Finiture / Finishes: ■ SS + Zinc plated

CHEMOLLI FIREBOLT A7

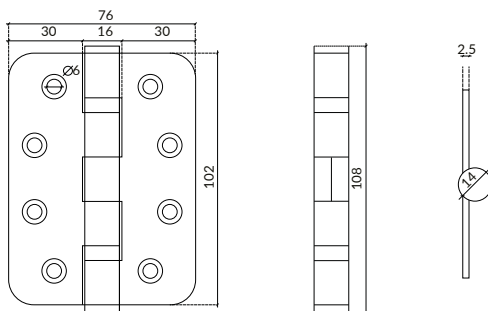

Cerniera metallica a due ali

Chemolli Firebolt A7 è una cerniera metallica a due ali di spessore 2.5 mm, realizzata in acciaio Inox (classe 304), peso 252 g, portata 50 Kg a coppia.

Stainless steel butt hinge

2.5 mm thick butt metal hinge, made of stainless steel (class 304), weight of 252 g, load up to 50 kg per pair.



Finiture / Finishes: ■ SSS



CHEMOLLI s.r.l.
a socio unico

Via Sant'Alessandro, 2/E - 38066
Riva del Garda (TN) - Italy
+39 0464 518969

chemollifire.com
info@chemollifire.com
C.F. e P.I. 02261290221