



 **PFEIFER**

Product range

Pfeifer and timber – a combination that has stood for quality and durability since 1948. Both values have their origins in a culture of innovation. Our need for development arises from our enthusiasm for the fascinating material that is wood. As a family business, we offer a reliable framework to continuously cultivate this passion.

*We connect people,
nature and technology.
For better wood solutions.*

[pfeifergroup.com](https://www.pfeifergroup.com)

CONTENTS

12-39 TIMBER CONSTRUCTION

Cross Laminated Timber	14-19
Glulam	20-23
Single- and three-ply solid wood panels	24-31
Construction timber	32-35
Tongue boards	36-38
Laths	39

40-51 SAWN TIMBER

Sawn timber	42-47
Profiled timber	48-51

52-65 CONCRETE FORMWORK

Shuttering panels	54-57
Formwork beams	58-65

66-75 ENERGY

Pellets	68-71
Briquettes	72-75

76-85 PALLET BLOCKS AND PACKAGING TIMBER

Pallet blocks	78-81
Packaging timber	82-85

86-89 LITTER

90-97 PÖLKKY SAWN TIMBER

Sawn timber	92-94
Profiled timber exterior	95
Profiled timber interior	96

98-109 PÖLKKY TIMBER CONSTRUCTION

Frame wood/logs	100-103
Glulam	104-106
Glulam posts	107
Resawn glulam	108
Glulam elements	109

110-113 PÖLKKY PRESSURE-TREATED WOOD

114-117 PÖLKKY WOOD FLOORS

118-121 PÖLKKY LITTER

122-123 PRODUCT INFORMATION

124 CONTACT

126 SITE NOTICE

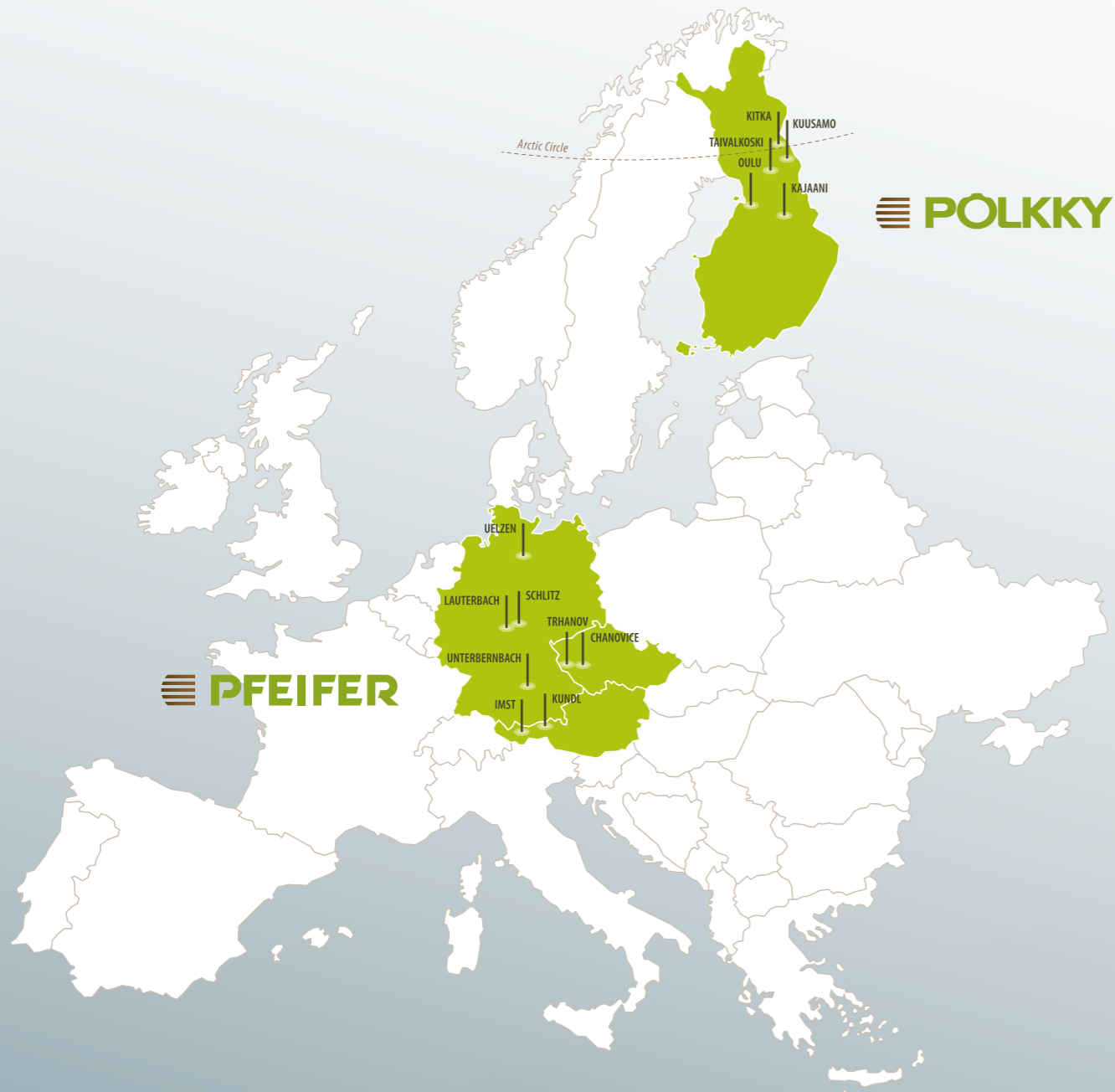

- 2,600 employees
- 4 countries
- 13 production sites
- 1.4 billion euros in revenue
- 5.4 million solid cubic metres of logs

PFEIFER

The company was founded in 1948 and is now a third-generation **family-owned business**. The Pfeifer Group employs **2,600 employees** at **13 sites** in Austria, Germany, the Czech Republic and Finland.

The company's head office is in **Imst** (Tyrol/Austria). Around **5.4 million solid cubic metres of timber** is cut every year in the Group's **sawmills**. This is then processed along the entire **value-added chain** into sawn timber, packaging timber, planed timber, profiled timber, shuttering panels, formwork beams, cross laminated timber, glulam, solid wood panels, pallet blocks, briquettes, pellets, litter and green electricity.

PFEIFER

PRODUCT RANGE

TIMBER CONSTRUCTION

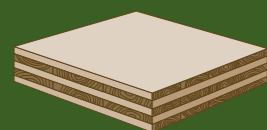

Cross Laminated Timber
Pages 14-19

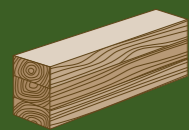

Glulam
Pages 20-23

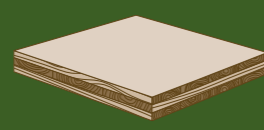

Single- and three-ply solid wood panels
Pages 24-31

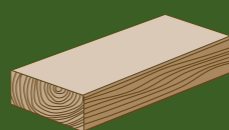

Construction timber
Pages 32-35

TIMBER CONSTRUCTION

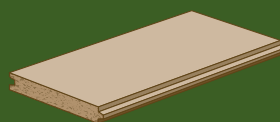

Tongue boards
Pages 36-38



Laths
Page 39

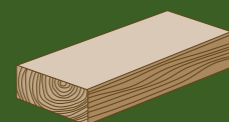

Sawn timber
Pages 42-47

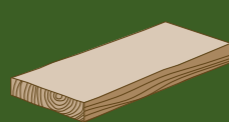

Profiled timber
Pages 48-51

SAWN TIMBER

CONCRETE FORMWORK

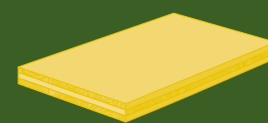

Shuttering panels
Pages 54-57



Formwork beams
Pages 58-65

ENERGY



Pellets
Pages 68-71

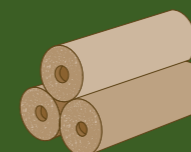

Briquettes
Pages 72-75

PALLET BLOCKS AND PACKAGING TIMBER



Pallet blocks
Pages 78-81

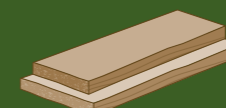

Packaging timber
Pages 82-85

LITTER



Litter
Pages 88-89

PÖLKKY

PRODUCT RANGE

SAWN TIMBER

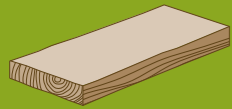

Sawn timber
Pages 92-94

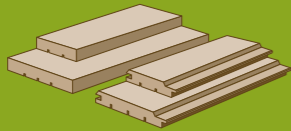

Profiled timber exterior
Page 95

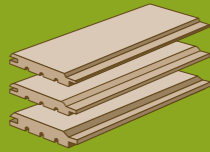

Profiled timber interior
Page 96

TIMBER CONSTRUCTION

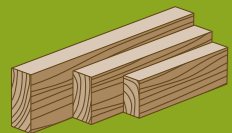

Frame wood/logs
Pages 100-103

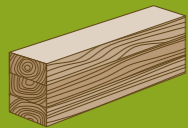

Glulam
Pages 104-106

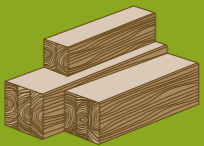

Glulam posts
Page 107



Resawn glulam
Page 108

TIMBER CONSTRUCTION

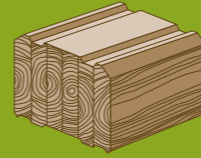

Glulam elements
Page 109

PRESSURE-TREATED WOOD

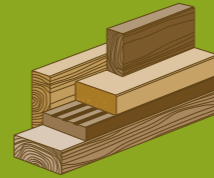

Pressure-treated wood
Pages 112-113

WOOD FLOORS

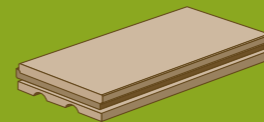

Solid wood floors
Pages 116-117

LITTER



Litter
Pages 120-121

TIMBER CONSTRUCTION

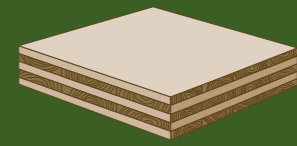

Pages 14-19

**Cross Laminated
Timber**

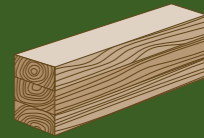

Pages 20-23

Glulam

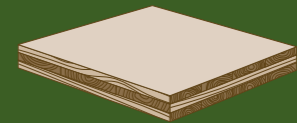

Pages 24-31

**Single- and three-ply
solid wood panels**

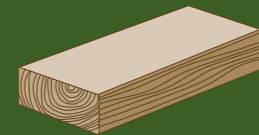

Pages 32-35

Construction timber

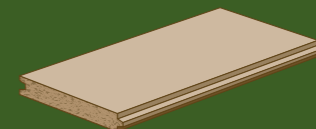

Pages 36-38

Tongue boards



Page 39

Laths

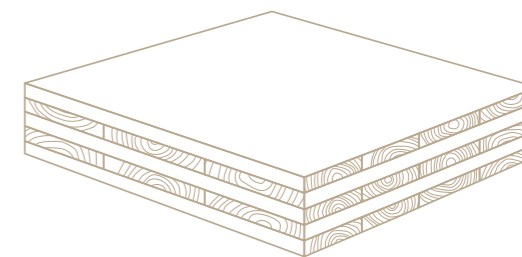

TIMBER CONSTRUCTION

Cross Laminated Timber

CROSS LAMINATED TIMBER



PFEIFER CLT is a large-format solid timber panel with maximum 15 layers of timber lamellas glued crosswise. Dried, strength- and quality-assorted, planed timber lamellas made of European

soft wood as well as formaldehyde-free polyurethane (PU) adhesive are used.

FEATURES

Product name: Pfeifer CLT Brettsperrholz

Approval: 20/0023

Application: Load bearing and non-load-bearing construction elements in buildings and timber structures such as walls, ceilings or roofs

Use class: 1 and 2 (according to EN 1995)

Board construction: 3 to max. 15 crossed and glued layers (standard: 3 to 7 layers)

Layer option: max. 3 fibre-parallel layers (≤ 90 mm) possible

Board length: up to 14.50 m

Panel width: up to 3.10 m

Board thickness: 60-280 mm (standard), up to 320 mm on request

Lamella thicknesses: 20, 30 or 40 mm

Strength class of raw material: C24; a proportion of max. 10% C16 is permissible (acc. EN 338)

Surfaces: industrial quality (IQ), industrial visible quality (ISQ) and visible quality (WSQ)

Types of wood: Europ. soft wood

Wood humidity: $12 \pm 2\%$ (at the time of delivery)

Dimensional stability:

longitudinal and crossways of the level of the board:
 0.01% per % of change in wood humidity

At right angles to the level of the board:
 0.20% per % change in humidity content of the wood

Adhesive: Polyurethane (PU) adhesive (formaldehyde-free) for finger-jointing and surface glueing (according to EN 301 or EN 15425)

Weight: approx. 480 kg/m^3 (to determine the transport weight)

Diffusion resistance: $\mu = \text{ca. } 60$ (at $u = 12 \pm 2\%$)

Air tightness: Class 4 (according to EN 12207)

Airtight from 3 layers according to Report HFA of 29/11/2019

Thermal conductivity: $\lambda = 0.12 \text{ W/(m.K)}$

Specific heat capacity: $c_p = 1.600 \text{ J/(kg.K)}$

Fire performance: D-s2, d0 (according to EN 13501)

Fire resistance / charring rate: $\sim 0.7 \text{ mm/min.}$
(for approximate calculations)

Recycling: Waste code: 17 02 01
(according to the Waste Incineration Ordinance (AVV))

Formaldehyde class: E1 Equalisation concentration 0.01 ppm
(according to Report HFA No. DLR 500038/2021 of 11/10/2021)

DELIVERY PROGRAMME

PFEIFER	GRAIN DIRECTION	BOARD CONSTRUCTION	THICKNESS	LENGTHS	INVOICED WIDTH	WEIGHT*
CLT		[mm]	[mm]	[m]	[m]	[kg/m ²]
3s						
60	Top layer lengthwise and crosswise possible DQ/DL	20-20-20	60	8.00 m to 14.50 m	2.45 to 3.10 m in 5 cm steps	28.8
80		30-20-30	80			38.4
90		30-30-30	90			43.2
100		30-40-30	100			48.0
110		40-30-40	110			52.8
120		40-40-40	120			57.6
5s						
100	Top layer lengthwise and crosswise possible DQ/DL	20-20-20-20-20	100	8.00 m to 14.50 m	2.45 to 3.10 m in 5 cm steps	48.0
120		30-20-20-20-30	120			57.6
140		40-20-20-20-40	140			67.2
150		40-20-30-20-40	150			72
160		40-20-40-20-40	160			76.8
180		40-30-40-30-40	180			86.4
200		40-40-40-40-40	200			96.0
7s						
180	Top layer lengthwise and crosswise possible DQ/DL	30-20-30-20-30-20-30	180	8.00 m to 14.50 m	2.45 to 3.10 m in 5 cm steps	86.4
200		20-40-20-40-20-40-20	200			96.0
220		30-30-30-40-30-30-30	220			105.6
240		30-40-30-40-30-40-30	240			115.2
260		30-40-40-40-40-40-30	260			124.8
280		40-40-40-40-40-40-40	280			134.4
7ss						
180	Top layer lengthwise and crosswise possible DQ/DL	30-30-20-20-20-30-30	180	8.00 m to 14.50 m	2.45 to 3.10 m in 5 cm steps	86.4
200		30-30-30-20-30-30-30	200			96.0
220		30-30-30-40-30-30-30	220			105.6
240		40-40-20-40-20-40-40	240			115.2
260		40-40-30-40-30-40-40	260			124.8
280		40-40-40-40-40-40-40	280			134.4

* Calculation with 480 kg/m^3

ss Top layers consist of two longitudinal layers
Further board constructions possible on request.



Detailed information
can be found in our special
Pfeifer CLT brochures.



SURFACE QUALITIES

	INDUSTRIAL QUALITY (IQ)	INDUSTRIAL VISIBLE QUALITY	VISIBLE QUALITY
Area of application	Purely structural components for subsequent cladding (e.g., with plasterboards or 3-layer boards)	Visible components in subordinate areas, e.g., in commercial and industrial buildings or which are noticeable at a greater distance (e.g., canopies), can only be used to a limited extent in residential areas	Visible components, especially for living areas. But also for kindergartens, schools and office areas. Treatment of the surface (on site) recommended (e.g., with varnish, UV protection,...)
Requirements on the surface	No visual requirements on the surface, purely strength-oriented features (C24) with isolated gaps, knot holes in the outer layers, glue penetration and occasional pressure points and dirt may occur, discoloration (e.g. blue stain) possible, glue penetration possible.	Medium requirements, increased optical criteria for cover lamellas, individual small gaps; slight discoloration is possible	High requirement, special requirements with regard to a homogeneous surface structure and lamella quality, occasional minor/slight discoloration possible
Production-related technical information	Finger-jointing visible in the outer lamellas without edge glueing	Finger-jointing visible in the outer lamellas; to avoid shrinkage cracks, no edge glueing of lamellas	Finger-jointing visible in the cover lamellas; to avoid shrinkage cracks, no edge glueing of lamellas
Chamfer	Without chamfer	Chamfer (approx. 5 mm) for DL panels (at the panels edges), DQ panels without chamfer	Chamfer (approx. 5 mm) for DL panels (at the panel edges), DQ panels without chamfer
Machining of the surface at the factory	Lamellas planed; only sanded on request; cross cut with DQ boards possible	Full-surface sanding (one side or both sides); 90° sanding on DQ panels is possible	Full-surface sanding (one side or both sides); 90° sanding on DQ panels is possible
Surface treatment at the factory	Not possible	Not possible	Possible on request from external partners
Wood humidity (approx.) as delivered	12 +/- 2%	12 +/- 2%	12 +/- 2%
Cracks Joints	Wood is a natural product. Therefore, as with all structural solid wood products, crack and gap formation due to shrinkage to the later equilibrium humidity content (EMC) in the state of use is product-specific and cannot be avoided. The lamellas are not edge glued		

- Visible surfaces should always be sampled: contact us
- Exact criteria (e.g., branch sizes,...) for the surface options: on request or at www.pfeifergroup.com

- Quality surfaces are possible on one or both sides; the optical criteria do not apply to the narrow/front sides and machining edges
- For visible quality surfaces, changing the panel structure may be necessary

AREAS OF APPLICATION

The versatility of the CLT material opens up completely new possibilities for creative, aesthetic solutions and inspires the imagination of planners. Pfeifer is the right partner and supplier

of high-quality components for individual applications. CNC-controlled joining basically sets no limits to the shape of a component made of Cross Laminated Timber.

WALL

PFEIFER CLT wall elements meet all static, structural and fire protection requirements. The completely joined wall elements, including cut-outs for windows, doors and installations, are delivered to the construction site ready for use.

+ Two-axis load-dissipating effect: high vertical load transfer possible. High horizontal load capacity for building reinforcement

+ Profitable use in multi-storey residential and industrial buildings

Advantages

+ Can be used as outer walls, inner walls and partitions in flats

+ High degree of prefabrication with all openings and outlets

+ Living area with quality wood for a visually and haptically great atmosphere

CEILING

The design of floors with PFEIFER CLT stands out due to its self-supporting and dry construction. Large-format, dimensionally stable components create a panel effect and can be installed with finished visible surfaces, enhancing comfort and quality of living.

+ Jointless installation, no larger contraction joints

+ High degree of prefabrication

+ Dry construction

+ High thermal storage mass in winter / insulator in summer

+ Finished visible surfaces = finished floor covering or finished soffit

Advantages

+ Two-axis load-dissipating effect: load-bearing effect can be ideally used in the case of construction of additional storeys

ROOF (FLAT ROOF/SLOPING ROOF)

In principle, any roof shape can be used with CLT. Roof constructions made of PFEIFER CLT meet all static, fire protection and acoustic requirements. The excellent thermal insulation and storage properties of wood ensure a pleasant indoor climate in both winter and summer.

+ Large spans

+ High degree of prefabrication

+ Immediate impermeability thanks to quick installation within a few hours

+ Dry construction

+ High thermal storage mass in winter / insulator in summer

Advantages

+ Two-axis load-dissipating effect: protrusions and breakthroughs in new dimensions

+ Finished visible surfaces / pleasant wooden surfaces for comfort

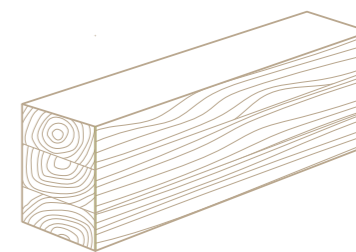

TIMBER CONSTRUCTION

Glulam

GLULAM



PRODUCT RANGE

Type of wood: spruce/fir

Strength categories: GL24c / G L24h, higher strengths on request: GL28c / GL28h / GL30c / GL30h
Widths 60 and 80 mm only for strength grade GL24 cs
Widths 220, 240, 260 and 280 mm only in strength grade GL 24

Quality: visual quality (Si), industrial quality (NSi), standard quality (Si unpatched)

Length: 6 to 24 m

Width: width: 60 to 280 mm (in a 20 mm steps), 60/80mm widths: are split from one beam

Height: up to 1.280 mm, in 40 mm steps, intermediate heights on request

Minimal production length: 600 cm

Lamella thickness: approx. 40 mm

Size tolerances: width/height: ± 2 mm (upon delivery), length - 0 / + 5 mm or 0.1%

Cuts: ± 1 mm on request

Surface: planed on 4 sides, chamfered longitudinal edges

Wood humidity: $u = 12 \pm 2\%$

Glueing: melamine resin glue, light glued line, waterproof

Gross density: approx. 450 kg/m^3

Packaging: package-wrapped/on request individually wrapped

Monitoring institutes: Holzforschung Austria

Usage classes: NK1. NK2

Product standards: Manufacture according to EN 14080, finger-jointing according to EN 15497

Automatic strength grading: according to EN14081

FEATURES

Assessable: clearly defined material according to strength and quality

Standardised: high availability through standardised cross-sections

Economical: the high load-bearing capacity with low dead weight enables lean and economical constructions

Dimensionally stable: thanks to multi-layer glueing, dimensionally stable and minimum cracking as well as easy to machine and universally applicable

Chemically resistant: glulam is particularly suitable for chemically stressed constructions due to the natural corrosive resistance of wood

Highly fire-resistant: assessable and safe compared to other construction materials

A 100% natural building material: for a pleasant indoor climate and comfort

GLULAM ELEMENTS



KEY BENEFITS

Glulam elements for solid wood construction for roofs, ceilings and walls.

- Low dead weight with high load capacity
- Static pane design possible
- Lean constructions compared to, for example, wooden beam constructions
- Simple implementation details
- Pleasant indoor climate due to breathable (hygroscopic) material
- Easily machined
- Dry construction
- Short assembly times due to prefabrication

PROFILE OPTIONS

	SINGLE GROOVE	SINGLE GROOVE WITH REBATE	DOUBLE GROOVE	DOUBLE GROOVE WITH REBATE
Height (in 20 mm steps)	80 – 280 mm	100 – 280 mm	100 – 280 mm	140 – 280 mm
Groove depth	25 mm	25 mm	25 mm	25 mm
Groove height	20.5 mm	20.5 mm	20.5 mm	20.5 mm
Rebate depth		50 mm		50 mm
Rebate height		20 mm		20 mm

	GROOVE AND TONGUE	GROOVE AND TONGUE WITH REBATE	DOUBLE GROOVE AND TONGUE	DOUBLE GROOVE AND TONGUE WITH REBATE	REBATE
Height (in 20 mm steps)	60 – 140 mm	100 – 140 mm	100 – 280 mm	160 – 280 mm	60 – 280 mm
Groove depth	15 mm	15 mm	15 mm	15 mm	
Groove height	20.5 mm	20.5 mm	20.5 mm	20.5 mm	
Rebate depth		50 mm		50 mm	50 mm
Rebate height		20 mm		20 mm	20 mm

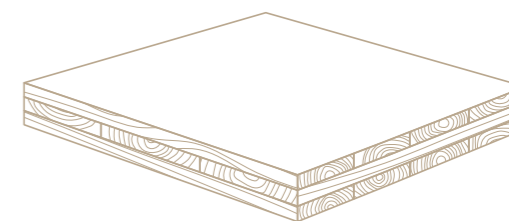

TIMBER CONSTRUCTION

Single- and three-ply solid wood panels

THREE-PLY SOLID WOOD PANELS



TECHNICAL DATA

Wood humidity: 10 +/- 2% upon delivery

Middle layers: tightly glued board middle layer in different widths

Top layers: 89 to 142 mm wide

Surface: natural, sanded on both sides

Gross density: approx. 450 kg/m³

Emission class: E1. formaldehyde content ≤ 0.01 ppm

Glueing: tested according to EN 13354 (boiling water-resistant glueing)

CE certification: according to EN 13 986:2004, EPH Dresden (SWP/3)

FEATURES

Dimensionally stable: dimensionally stable and accurate to size due to multi-layered crosswise glueing

Standardised: high availability through standardised formats and qualities

Natural: for a pleasant indoor climate and comfort

QUALITY DESCRIPTION 1-S & 3-S SOLID WOOD PANELS

A-quality: surface sanded, free from cracks and joints, healthy full grown branches, single black or black-edged branches up to max. 20 mm in diameter, patches of black branches permitted, free from medullary tubes (except for isolated ones), healthy wood, staining and fungal infestation not permitted, practically box-free (light box allowed).

B-quality: surface sanded, free from joints, a few fine cracks permitted, black branches and patch branches permitted (but no accumulations), medullary tubes are permitted in isolated cases, resin galls up to 5 x 50 mm, light box, small bark ingrowths up to approx. 1.5 cm are permitted in isolated cases.

C-quality: surface sanded, knotholes patched, there can be small joints on individual panels (max. 2-3 mm), otherwise no special quality requirements.

Minimum cracking: (10% +/- 2%) and professional machining of cover lamellas and the middle layer

Aesthetic: balanced surface appearance through careful sorting

Stable: good load-bearing capacity with low dead weight

Versatile: easy to machine and versatile to use

DELIVERY PROGRAMME

European spruce

QUALITY	AB/B	B/C	B/K	C/C	C/K	QTY./PU	PANEL STRUCTURE
<i>FORMAT</i> 5,000 x 1.025 / 5,000 x 2,050 mm							
16 mm	○	●	●	●	●	35	4/8/4
19 mm	●	●	●	●	●	30	6/7/6
22 mm	–	●	●	●	●	25	6/10/6
27 mm ¹	●	●	●	●	●	21	9/9/9
32 mm	–	●	●	●	●	17	9/14/9
42 mm	–	●	●	●	●	13	9/24/9
50 mm	–	●	●	●	●	11	9/32/9
60 mm	–	●	●	●	●	9	14/32/14
<i>FORMAT</i> 5,000 x 1.250 / 5,000 x 2,500 mm							
19 mm	–	●	●	●	●	30	6/7/6
27 mm ¹	–	●	●	●	●	21	9/9/9
42 mm	–	●	●	●	●	13	9/24/9
50 mm	–	●	●	●	●	11	9/32/9
60 mm	–	●	●	●	●	9	14/32/14
<i>FORMAT</i> 6,000 x 1.025 / 6,000 x 2,050 mm							
19 mm	–	●	●	●	●	25	6/7/6
27 mm	–	●	●	●	●	18	9/9/9
42 mm	–	●	●	●	●	11	9/24/9
50 mm	–	●	●	●	●	9	9/32/9
60 mm	–	●	●	●	●	8	14/32/14
<i>FORMAT</i> 6,000 x 1.250 / 6,000 x 2,500 mm							
19 mm	–	●	●	●	●	25	6/7/6
27 mm	–	●	●	●	●	18	9/9/9
42 mm	–	●	●	●	●	11	9/24/9
50 mm	–	●	●	●	●	9	9/32/9
60 mm	–	●	●	●	●	8	14/32/14

Larch

QUALITY	AB/C	–	–	–	–	QTY./PU	PANEL STRUCTURE
<i>FORMAT</i> 5,000 x 2,050 mm							
19 mm	●	–	–	–	–	30	6/7/6
27 mm	●	–	–	–	–	21	9/9/9

¹ 27 mm format, 6 mm top layer only ex works from 1mst possible

² On request, not all sizes are always in stock

● available ○ out of stock, order-related production

THREE-PLY SOLID WOOD PANELS WITH GROOVE AND TONGUE



DELIVERY PROGRAMME

Laying panel made of spruce, long side with wedge tongue/wedge groove

QUALITY	AB/B	B/C	B/K	C/C	C/K	QTY./PU	PANEL STRUCTURE
FORMAT				5,000 x 665 / 5,000 x 1.010 mm			
19 mm	–	–	●	–	–	30	6/7/6
22 mm	–	–	●	–	–	25	6/10/6
27 mm	–	–	●	–	–	21	9/9/9

Laying panel made of spruce – 4-sided with wedge tongue/wedge groove

QUALITY	AB/B	B/C	B/K	C/C	C/K	QTY./PU	PANEL STRUCTURE
FORMAT				2,480 x 665 mm			
19 mm	–	–	●	–	–	30	6/7/6
27 mm	–	–	●	–	–	21	9/9/9

Laying panel made of larch, long side with wedge tongue/wedge groove

QUALITY	AB/B	B/C	B/K	C/C	C/K	QTY./PU	PANEL STRUCTURE
FORMAT				5,000 x 665 mm / 5,000 x 1.010 mm			
19 mm	●	–	–	–	–	30	6/7/6
27 mm	●	–	–	–	–	21	9/9/9

Laying panel made of larch - 4-sided with wedge tongue/wedge groove

QUALITY	AB/B	B/C	B/K	C/C	C/K	QTY./PU	PANEL STRUCTURE
FORMAT				2,480 x 665 mm			
19 mm	●	–	–	–	–	30	6/7/6
27 mm	●	–	–	–	–	21	9/9/9

¹ 27 mm format, 6 mm top layer only ex works from 1mst possible

² On request, not all sizes are always in stock

● available ○ out of stock, order-related production

SINGLE-PLY SOLID WOOD PANELS



TECHNICAL DATA

Wood humidity: 10 +/- 2% upon delivery

Slat width: 43 to 45 mm

Surface: natural, sanded on both sides (K 80)

Gross density: approx. 450 kg/m³

Emission class: E1. formaldehyde content ≤ 0.01 ppm

CE certification: according to EN 13353:2011 (SWP/1), for non-supporting purposes

Glueing: tested according to EN 13354 (boiling water-resistant glueing)

DELIVERY PROGRAMME

European spruce

QUALITY	A	B	C	QTY./PU
FORMAT	5,000 x 1.025 / 5,000 x 1.230 mm			
14 mm	○	○	○	40
18 mm	○	○	○	30
21 mm	○	○	○	26
24 mm	○	○	○	23
27 mm	○	○	○	21
34 mm	○	○	○	16
42 mm	○	○	○	13

² On request, not all sizes are always in stock

○ out of stock, order-related production



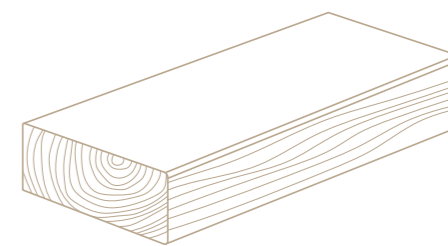

TIMBER CONSTRUCTION

Construction timber

CONSTRUCTION TIMBER 5 METRES



PRODUCT RANGE

Type of wood: spruce

Quality: NSi

Length: 5 m

Surface: levelled

Wood humidity: $15 \pm 3\%$

Packaging: package-wrapped

DIMENSIONS AND PACKAGING UNITS

WIDTH mm	HEIGHT mm	BUNDLED/LOOSE	TOTAL Qty.
27	60	bundled	378
30	60	bundled	324
40	60	bundled	216
40	80	bundled	168
60	60	loose	162
60	80	loose	117
60	100	loose	99
60	120	loose	81
60	140	loose	72
60	160	loose	63
60	180	loose	54
60	200	loose	45
80	80	loose	98
80	100	loose	77
80	120	loose	63
80	160	loose	49
100	100	loose	55
100	120	loose	45
100	140	loose	40
100	160	loose	35



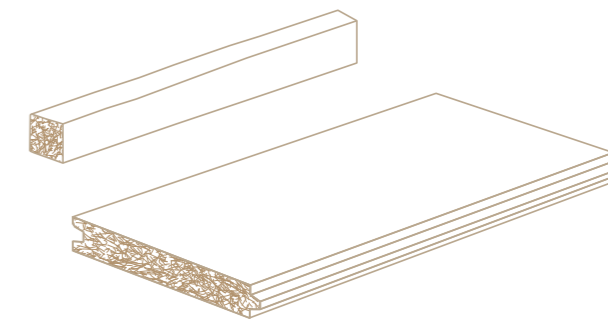

TIMBER CONSTRUCTION

Tongue boards & laths

TONGUE BOARDS



PROFILE OPTIONS

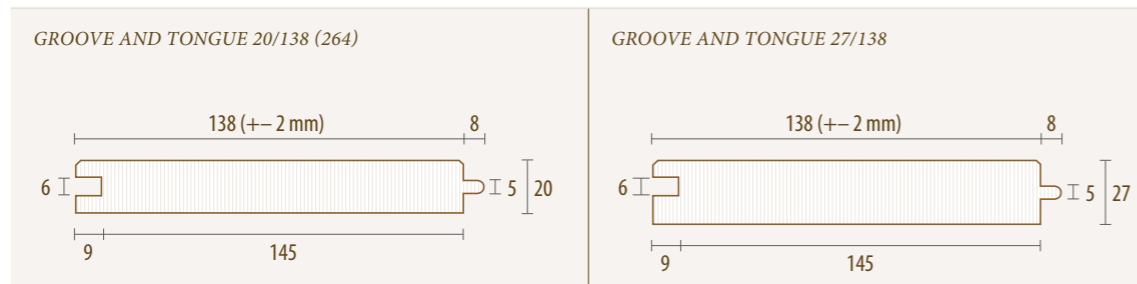

	20/138 (264)	27/138 (200)
Dimension	20/138 (264)	27/138 (200)
Piece	208	144
Height	50	50
Width	100	100

PRODUCT RANGE

Type of wood: spruce

Surface: levelled, sharp-edged

Wood humidity: max. 15%

Packaging: foil-coated

Sorting: A/B/C

Length: 5 m, trimmed

LATHS



DIMENSIONS AND PACKAGING UNITS

STRENGTH mm	WIDTH mm	LENGTH m	BUNDLED/LOOSE	PIECE PER PACK
23	48	4	bundled	1.152
28 **	38 **	5	bundled	1.120
28	48	4	bundled	960
38	38	4	bundled	840
38	48	5	bundled	630
38	58	4	bundled	540
38	78	4	bundled	392
48	48	4	bundled	504
48	58	4	bundled	432
48	68	4	bundled	384
48	78	4	bundled	336
48	98	4	bundled	240
58	78	4	bundled	252
78	78	4	loose	196
78	98	4	loose	154
98	98	4	loose	121

* planed, sorting 3/4/5

** only on request

SAWNTIMBER

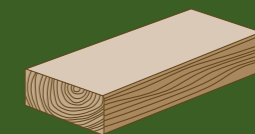

Pages 42-47
Sawn timber

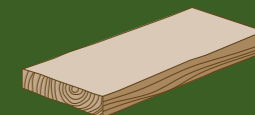

Pages 48-51
Profiled timber

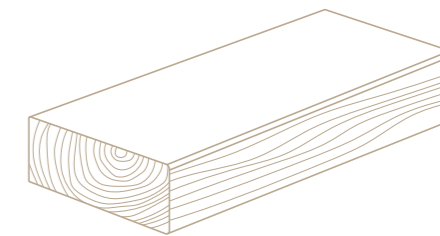

SAWN TIMBER

Sawn timber

SAWN TIMBER



PRODUCT RANGE

- BSH slats in visual and industrial quality
- KVH raw material for visibility and non-visibility, raw material for glued laminated timber
- Raw material for planing mills
- Panel raw material
- Sawn timber for packaging, pallets and cable drums
- Centre layers for parquet and glued laminated timber
- Formwork
- Planks
- Squared timber
- Special dimensions according to customer requirements
- Fresh, slatted or unslatted, anti-blue treatment on request*

SUPPLY PLANTS	UNTERBERNBACH	UELZEN *	KUNDL	LAUTERBACH *	CHANOVICE
Type of wood	Spruce pine	Pine	Spruce	Spruce pine	Spruce
Thicknesses	12 – 130 mm	12 – 125 mm	10 – 160 mm	12 – 160 mm	13 – 160 mm
Widths	70 – 295 mm	70 – 245 mm	70 – 325 mm	70 – 315 mm	60 – 350 mm
Lengths in metres	Spruce 5.10 5.00 4.80 4.50 4.20 4.00 3.90 3.60 3.00 Spruce/fir/pine 3.60 3.00 2.50	Pine 2.40 2.00	Spruce 5.00 4.00 3.60 3.00	Spruce 5.00 4.00 3.60 4.00 3.50 3.00 Spruce/fir/pine 2.40 2.00	Spruce 5.00 4.00 3.60 3.00

THICKNESS in mm	WIDTH in mm	QUALITIES	STANDARD DRYING
<i>Main product spruce</i>			
22	100 / 120 / 150	0/4 + 4/5	17%
37	195 / 250 / 275	0/4 + 4/5	15%
43	125 / 145 / 165	0 – 4/2 – 4	15%
45	90 / 110 / 130 / 150 / 170 / 190 / 210 / 250	0 – 3/2 – 4 / 4 – 5	11%
46	210 / 235 / 255 / 275	0 – 3/2 – 4 / 4 – 5	11%
50	100 / 125 / 150 / 170 / 190 / 210 / 230 / 250	0 – 3/2 – 4 / 4 – 5	11 / 15%
63	105 / 125 / 145 / 165 / 185 / 205 / 225 / 245 / 265 / 285	0 – 4 / 4 – 5	15%
84	105 / 125 / 145 / 165 / 185 / 205 / 225 / 245 / 265 / 285	0 – 4 / 4 – 5	15%
105	105 / 125 / 145 / 165 / 185 / 205 / 225 / 245 / 265 / 285	0 – 4 / 4 – 5	15%
125	125 / 145 / 165 / 185 / 205 / 225 / 245 / 265 / 285	0 – 4 / 4 – 5	15%
146	146 / 207 / 247	0 – 4 / 4 – 5	15%
146	146 / 207 / 247	0 – 4 / 4 – 5	15%
<i>Main product pine</i>			
34	95 / 225	0 – 4 / 4 – 5	17%
37	250	0 – 4 / 4 – 5	17%
67	117	0 – 4 / 4 – 5	17%
76 / 78	96 / 98	0 – 5	17%
96	96 / 116	0 – 5	17%
<i>By-product spruce</i>			
12, 13	60 / 70	3 – 5	Fresh
14, 15	70 / 75 / 95	3 – 5	Fresh
17	75 / 78 / 95 / 98 / 115 / 133	3 – 5	Fresh
18	140 / 160	3 – 5	Fresh
21	95 / 115	3 – 5 / 5 – 6	Fresh
22, 23	78 / 100 / 120 / 125 / 145 / 150 / 175 / 200	3 – 5 / 5 – 6	17%
25	100 / 125 / 150 / 190	3 – 5 / 5 – 6	17%
28	98 / 140 / 150 / 180 / 200 / 210	3 – 5 / 5 – 6	17%
31	120 / 145 / 160 / 210	3 – 5 / 5 – 6	11%
33	150 / 170 / 190 / 210 / 230 / 250 / 275 / 290	3 – 5 / 5 – 6	11%
38	175 / 195 / 215 / 235 / 255	3 – 5 / 5 – 6	11%
<i>By-product PINE, pine/spruce mixed</i>			
22	100 / 120 / 145 / 200	3 – 5	17%
25	155 / 190 / 205	3 – 5	11%
35	150 / 170 mm	3 – 5 / 5/6	11%

CUTTING

Cutting on modern link and EWD chip profiling saw lines exclusively with circular saw cut. This ensures smooth surfaces, cutting accuracy and size accuracy.



Each trunk is optimally used by our image editing optimisation.

Main product

Side boards

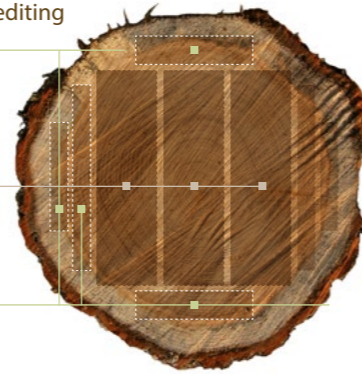

SAWN TIMBER SORTING

The sawn timber is sorted visually and, directly after cutting on high-performance sorting systems by continuously trained sorting personnel, supported by modern scanner technology. Sizes are always packaged separately according to thickness, width, length and quality.

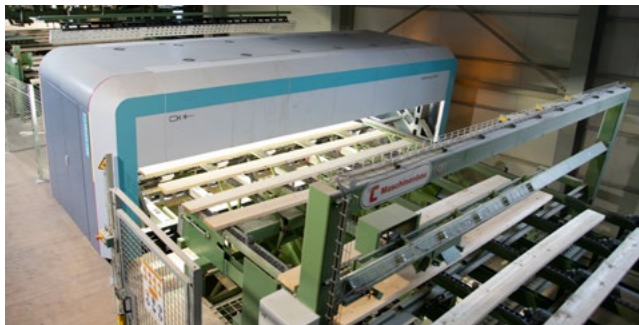

STANDARD SORTING FOR BOARDS

Depending on the intended use, we sort according to optical criteria in accordance with the German and Austrian sorting rules with always consistent quality standards.

A Sorting 0-3

Sharp-edged, free of blueness, red stripes, cracks, infestation by worms and insects, few black branches and resin galls, trimmed on both sides

AB Sorting 0-4

Mill-run, in principle sharp-edged, light blueness and light red stripes tolerated, free of rot, trimmed on both sides

B Sorting 2-4

Industry quality, in principle sharp-edged, blueness and nail-hard red stripes tolerated, free of rot, occasional insect infestation tolerated, trimmed on both sides

C Sorting 4/5

Partly tree edge, blueness, red stripes and insect infestation tolerated, trimmed on both sides

By-product/packaging material 3/4/5

Light tree edge and slight colour defects allowed, free from worm infestation

By-product/packaging rejects 5/6

Large tree edge, occasional cracks and occasional rotten spots tolerated

WOOD DRYING

In our drying chambers, the sawn timber can be dried to the desired humidity and then sorted to the agreed quality. In doing so, each board is also checked again for wood humidity.



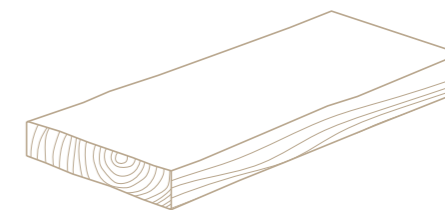

SAWN TIMBER

Profiled timber

PROFILED TIMBER



<i>Boards</i>	<i>Length</i>	<i>Quality</i>
19 x 89/140/184 mm (1 x 4/6/8")	3,048 / 3,658 / 4,267 / 4,877 mm 10' / 12' / 14' / 16'	#2 Premium #2 Premium
<i>Lumber dimensions</i>		
38 x 63/89/140/184/235/286 mm (2 x 4/6/8/10/12")	3,048 / 3,658 / 4,267 / 4,877 mm 10' / 12' / 14' / 16'	#2 Premium/MRNS
38 x 89/140 mm (2 x 4/6")	1,650 / 2,100 mm	MSR
<i>PET</i>		
38 x 89/140 mm	1,829 / 1,990 / 2,134 mm (72"/75"/84")	MRNS
38 x 89/140 mm	2,353 / 2,657 mm (92 5/8", 104 5/8")	#2
<i>CLS, C16</i>		
38 x 63/89/140 mm	2,400 / 4,200 / 4,800 / 5,100 mm	C16
<i>Carcassing, C24</i>		
45 x 95/120/145/170/195/220/245 mm	2,400 / 4,200 / 3,600 / 4,800 mm	C24

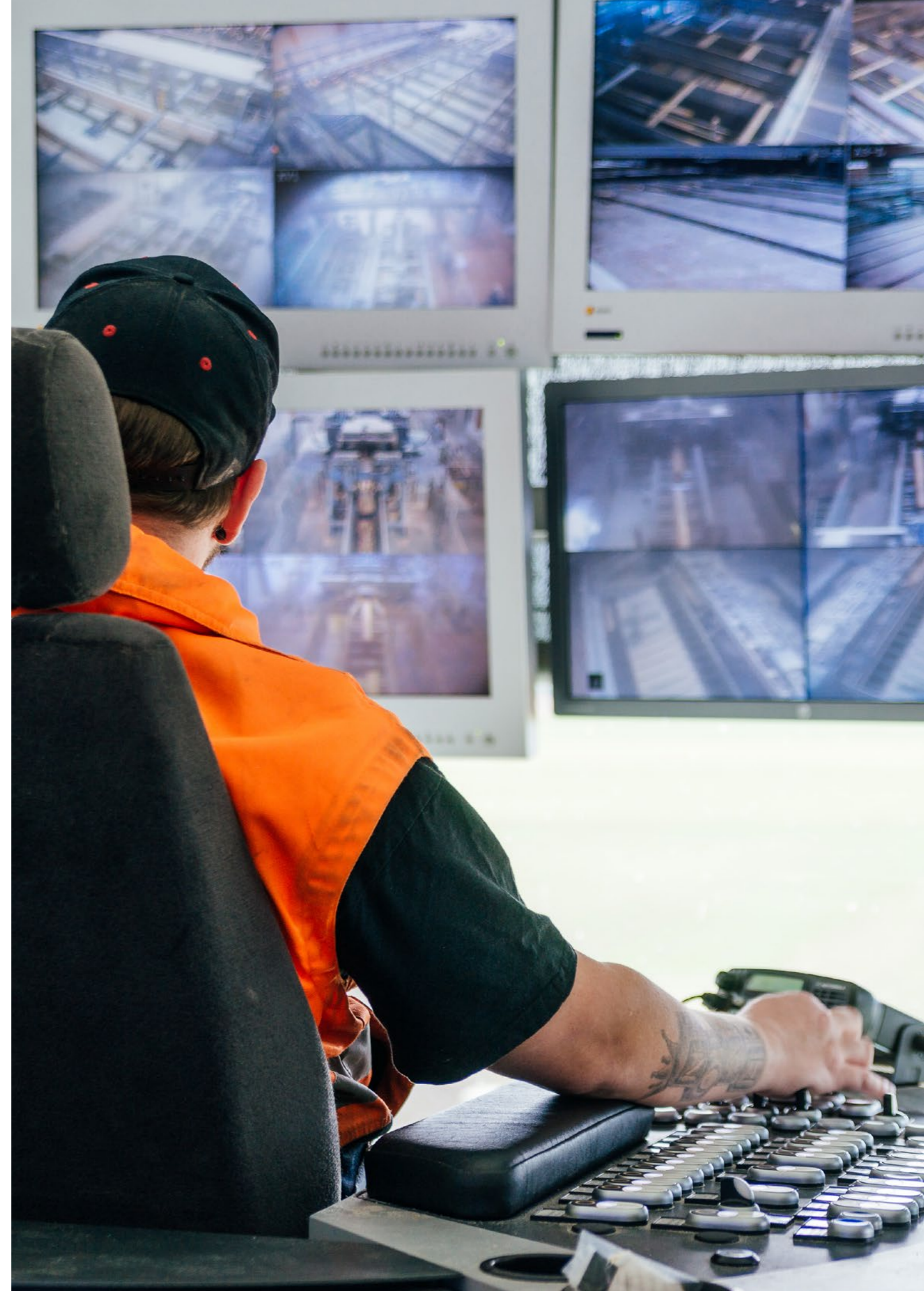

CONCRETE FORMWORK

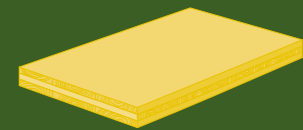

Pages 54-57
Shuttering panels



Pages 58-65
Formwork beams

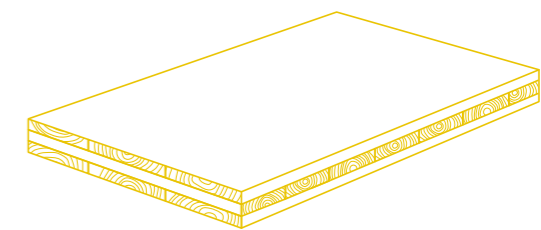

CONCRETE FORMWORK

Shuttering panels

SHUTTERING PANELS



FEATURES

- Type of wood: spruce / fir
- Accurate to size and dimensionally stable
- Time and cost-saving in machining
- A long service life is guaranteed with proper treatment
- Resistant surface treatment made of melamine resin (not 1-ply)
- Suitable for construction sites for stacking with supporting timber
- Water and weather resistant according to EN 13353 (SWP/3)
- Produced according to Austrian standard B 3023 three-ply concrete formwork panel
- Light weight

CONSTRUCTION

SHUTTERING PANELS (21) with edge bands

Thickness: 21 mm
 Width: 500 mm
 Lengths: 1.500 / 2.000 / 2.500 mm



SHUTTERING PANELS (21) with edge protection

Small formats with edge protection made of iron
 Thickness: 21 mm
 Width: 500 mm
 Lengths: 1.500 / 2.000 / 2.500 mm



CONSTRUCTION

SHUTTERING PANELS (27) without edge bands (on request)

Thickness: 27 mm
 Width: 500 mm
 Lengths: 1.500 / 2.000 / 2.500 / 3.000 mm

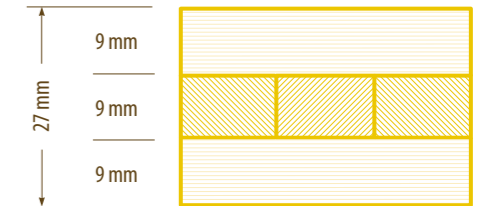

SHUTTERING PANELS (27) with edge bands

Thickness: 27 mm
 Width: 500 mm
 Lengths: 1.000 / 1.500 / 1.970 / 2.000 / 2.500 / 3.000 mm



SHUTTERING PANELS (27) Large formats

Thickness: 27 mm
 Width: 1.000 / 2.000 mm
 Lengths: 1.000 / 2.000 / 2.500 / 3.000 / 4.000 / 5.000 mm



FORMWORK (27)

Thickness: 27 mm
 Width: 200 / 250 / 300 / 350 / 400 mm
 Lengths: 3.000 mm

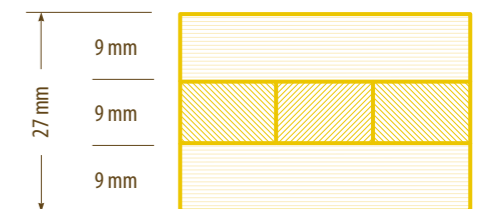

SOLID WOOD PANELS C20 with edge protection

Thickness: 20 mm
 Width: 500 mm
 Lengths: 1.500 / 2.000 mm



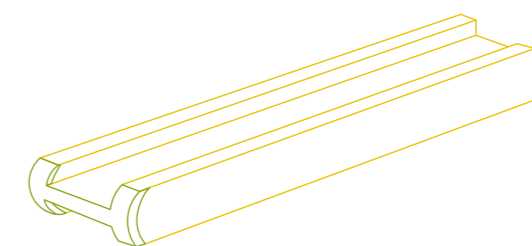

CONCRETE FORMWORK

Formwork beams

FORMWORK BEAMS

Formwork beams are designed in such a way that they are suitable for use under construction site conditions, such as, for example, the exposure to water and cement. Industrially manufactured formwork beams made of wood are intended for use in load-bearing structures and formwork, and may only be strained in the direction of the beam height.



FEATURES PF20_{PLUS}

- Beam ends and protective caps are rounded
- The entire front side is protected by the protective cap
- Handy, lightweight
- Shock resistant
- High dimensional stability
- Very low shrinkage
- Low risk of injury
- No glueing and no steel clips required to attach the protective cap
- Good mechanical properties of the protective cap at high and low temperatures
- The protective cap has a UV stabiliser against weathering

FEATURES PF20

- The beam ends are rounded
- The entire front side is protected against the influence of the weather by the special front-side glaze
- Handy, lightweight
- Shock resistant
- High dimensional stability
- Very low shrinkage
- No more risk of injury

PRODUCT FEATURES

PF20plus: End cap up to 9 m possible

PF20: Curvature with sealing up to 9 m possible – over 9 m only cut straight and sealed

Weight: approx. 4.5 kg/lfm

Bar thickness: 27 mm

Lengths: 190, 245, 265, 290, 330, 360, 390, 450, 490, 590 cm
Special lengths up to 11.90 m

Package units: 100 pieces per package

Package dimensions (w x h): 110 x 110 (100 pieces; without underlay)

Max. number of stacks on top of each other: 2 (100 pieces)

Wood humidity: 12 +/- 2% upon delivery

Dimensional tolerances: Height H = 200 +/- 2 mm;
Length tolerance: specified length +/- 10 mm

LABEL

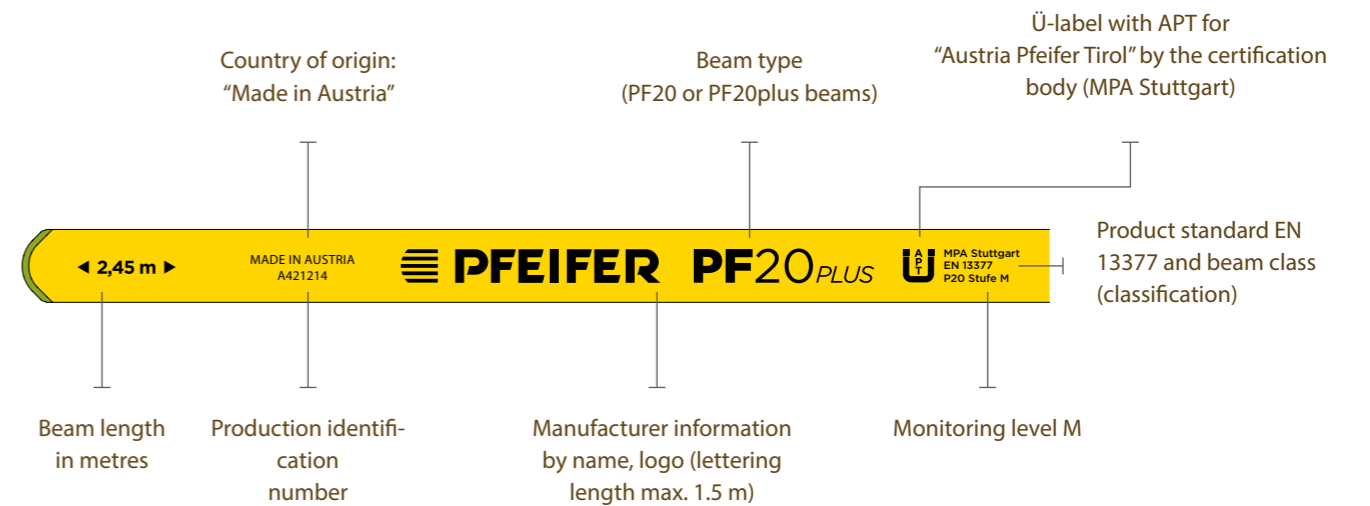

BEAM STACK

- Always stack beam stacks “sorted by model”, i.e., do not place PF 20 and H20 beams together in stacks
- The web thicknesses must be the same within a stack
- Edge protection is not necessary, i.e., the rounded edges are sufficient
- The floor must be as flat as possible
- The substrate must be adequately secured. Optimally, the storage areas should be concreted or paved
- With storage on asphalt, additional load distribution must be ensured by base wood
- With storage on other soils (gravel, sand, etc.), appropriate storage measures must be taken (e.g., base plates)



DIRECTIONS FOR USE

Pfeifer’s PF20 and PF20plus timber formwork beams are solid wall beams and are subject to monitoring level M according to EN13377 in conjunction with DIN 20000-2.

Monitoring and certification is carried out by the Materials Testing Institute of the University of Stuttgart. Certificate of conformity Reg. No.: BWU03-0639

These instructions for use serve to explain how the formwork beams should be used. However, Pfeifer’s solid wall formwork beams must be independently tested by the user for suitability for the intended purpose. Compliance with legal standards in the respective country of use is the responsibility of the user.



MAINTENANCE

- The beam should be protected from extreme weather conditions such as direct sunlight or wetness by being stored under a roof or covering. Complete wrapping of the beams should be avoided.
- Unchanging storage conditions reduce the formation of cracks and infestation by mould and fungi. After use, it should be possible to dry the beams.
- The following damage prohibits the static use of beams. The beams must be replaced in case of the following:
 - Oblique cracks (crosswise to the fibre)
 - Straight cracks (parallel to the chord) with a crack width of more than 2 mm
 - Side chippings deeper than 10 mm and longer than 500 mm
 - Oblique chippings over the edge wider than 30 mm and longer than 500 mm
 - Saw cuts deeper than 2 mm
 - Drill holes (excluding system drillings)

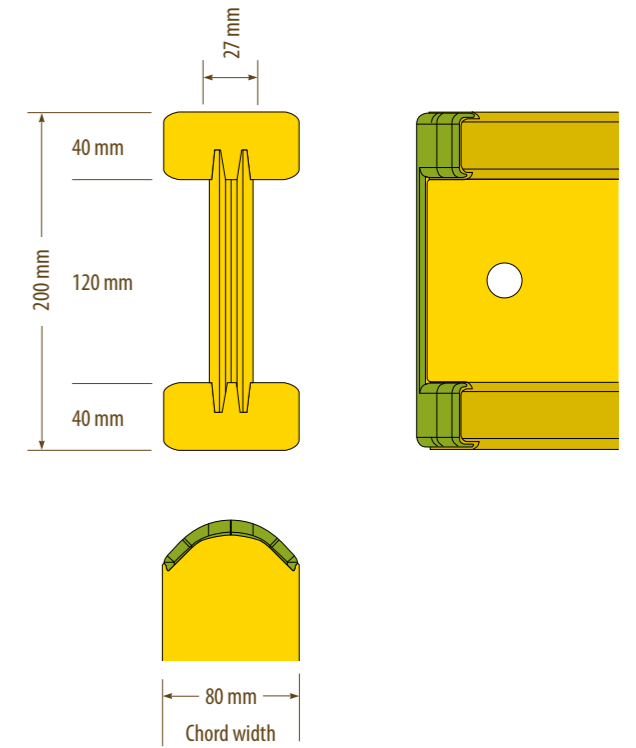

CHARACTERISTIC LIMIT VALUES ACCORDING TO EN 13377

Transverse force: $V_k = 23.9 \text{ kN}$

Bending moment: $M_k = 10.9 \text{ kNm}$

Bearing resistance: $R_{b,k} = 47.8 \text{ kN}$

Bending stiffness: $E_I = 450 \text{ kNm}^2$

DEFLECTION OF THE FORMWORK BEAM

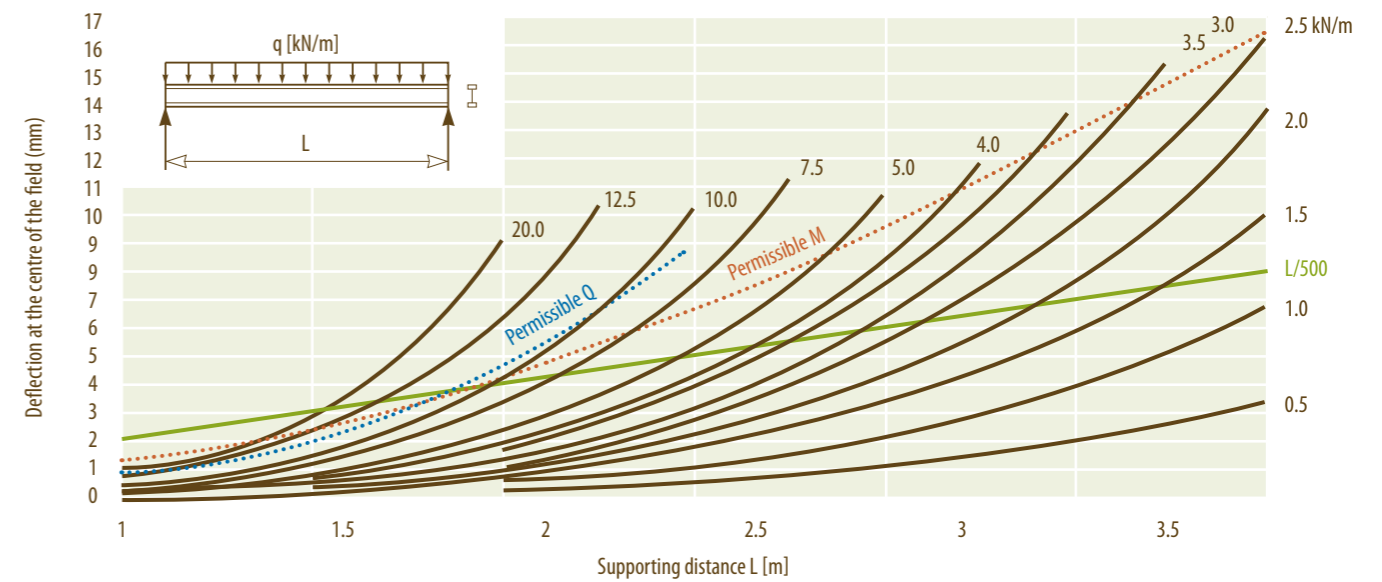

PERMISSIBLE LOADS FOR FULL-WALL BEAMS ACCORDING TO EN 13377

Transverse force Q = 11 kN

E-module EI = 450 kNm²

Bearing force A = 22 kN

The strength of the chords is sorted by machine

Bending moment M = 5 kNm

MARKING OF THE BEAM

- Beam length
- Manufacturer information by name, logo
- Own customer logos/labelling possible
- Beam type
- Classification
- Monitoring level M
- Production identification number
- Country of origin

SIZING OF CEILING TABLES

For the sizing of ceiling tables, please refer to our table with the max. permissible yoke beam, transverse beam and supporting

distances. The specified cut sizes must not be exceeded at any point on the timber formwork beams.

PROVISIONS FOR IMPLEMENTATION AND USE

- Assembly of the timber formwork beams must be carried out by qualified and trained employees and in accordance with our instructions for use.
- The permissible supporting width of PF20 and PF20plus beams must not exceed 4.0 m.
- The formwork shell must be nailed directly onto the top chord.
- Timber formwork beams may only be used upright. In addition, these must be secured against tilting in accordance with statics requirements.
- Changes to the product are not allowed and can lead to increased risk potential.
- Timber formwork beams may only be used for formwork work with concrete, no other usages are permitted.
- Before using the timber formwork beams, they must be checked each time by the installation company to ensure that they are in perfect condition.
- Damaged beams or beams that have been weakened by decay must not be used.
- When storing the timber formwork beams, care should be taken to ensure that they are not exposed to excessive weather influences and are not stored outdoors without protection. Professional storage increases the overall service life and reduces deformation and cracks.

SIZING TABLE

CASE STUDY

Given: Ceiling thickness (18 cm) + cross beam distance (75 cm)

Wanted: yoke beam distance + support distance

- 1 Ceiling thickness: 18 cm
- 2 Cross beam distance: 75 cm
- 3 Permissible yoke beam distance according to Table 1 = 2.65 m
- 4 Equate or choose the next smaller yoke beam distance in Table 2 = 2.5 m
- 5 In Table 2 of column 2.5, read the permissible supporting distance depending on the ceiling thickness (18 cm): 1.36 m
- 6 Attention: the supports must be checked regarding the corresponding load capacity!

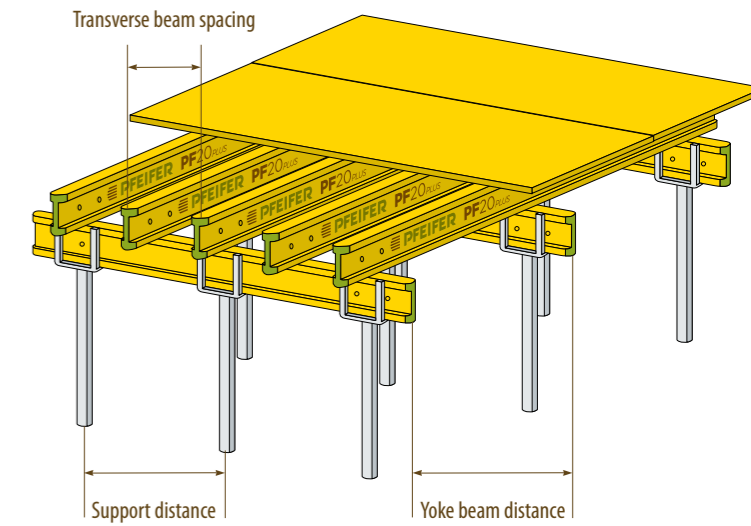

		TABLE 1				TABLE 2								
		Transverse beam distance [m]				Yoke carrier distance [m]								
		0.50	0.63	0.67	0.75	1.00	1.25	1.50	1.75	2.00	2.25	2.50	3.00	3.50
CEILING THICKNESS in cm	TOTAL LOAD kN/m ²	PERMISSIBLE SPAN WIDTH FOR TRANSVERSE BEAM [m]				PERMISSIBLE SPAN WIDTH FOR YOKE BEAM [m] = MAX. DISTANCE OF THE CEILING SUPPORTS								
10	4.40	3.63	3.37	3.29	3.17	2.88	2.67	2.46	2.28	2.13	2.01	1.91	1.67	1.43
12	4.92	3.43	3.19	3.12	3.00	2.72	2.53	2.33	2.16	2.02	1.90	1.79	1.49	1.28
14	5.44	3.27	3.04	2.97	2.86	2.60	2.41	2.21	2.05	1.92	1.80	1.62	1.35	1.16
16	5.96	3.14	2.92	2.85	2.74	2.49	2.31	2.12	1.90	1.83	1.64	1.48	1.23	1.05
18	6.48	3.03	2.81	2.75	2.65	2.40	2.22	2.03	1.88	1.70	1.51	1.36	1.13	0.97
20	7.00	2.93	2.72	2.66	2.56	2.32	2.14	1.95	1.80	1.57	1.40	1.2	1.05	0.90
22	7.52	2.84	2.64	2.58	2.48	2.26	2.06	1.88	1.67	1.46	1.30	1.17	0.98	0.84
24	8.04	2.76	2.57	2.51	2.42	2.19	2.00	1.82	1.56	1.37	1.22	1.09	0.91	0.78
26	8.56	2.70	2.50	2.45	2.35	2.14	1.93	1.71	1.47	1.29	1.14	1.03	0.86	0.73
28	9.08	2.63	2.44	2.39	2.30	2.09	1.88	1.62	1.38	1.21	1.08	0.97	0.81	0.69
30	9.66	2.57	2.39	2.34	2.25	2.03	1.82	1.52	1.40	1.14	1.01	0.91	0.76	0.65
35	11.22	2.45	2.27	2.23	2.14	1.89	1.57	1.31	1.12	0.98	0.87	0.78	0.65	0.56
40	12.78	2.35	2.18	2.13	2.04	1.72	1.38	1.15	0.98	0.86	0.77	0.69	0.57	0.49
45	14.34	2.26	2.10	2.04		1.53	1.23	1.02	0.88	0.77	0.68	0.61	0.51	0.44
50	15.90	2.18	2.01	1.94		1.38	1.11	0.92	0.79	0.69	0.61	0.55	0.46	0.40

Deflection of the beams is limited to L/500. Live load is 1.5 kN/m² or 20% of the fresh concrete weight.

ENERGY



Pages 68-71
Pellets

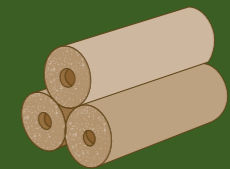

Pages 72-75
Briquettes

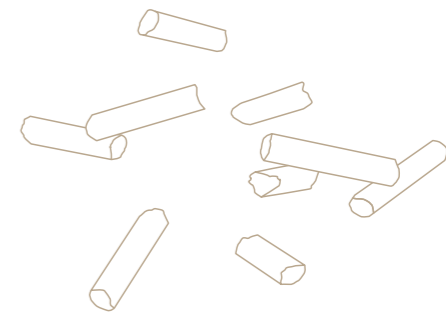

ENERGY

Pellets

PELLETS



The Pfeifer concept exemplifies the ecological and economic use of timber. Short distances for the timber supply. We use tree bark to fuel our power plant and generate heat and power.

The logs are processed into sawn timber, and the sawdust produced during the sawing process is turned into wood pellets. These pellets are a carbon-neutral fuel, making an active contribution to climate protection.

FEATURES

Length: 5 to 40 mm
Diameter: 6 mm

High density, no cracks

High energy value: ~4.9 kWh/kg
(2 kg of pellets = approx. 1 litre of heating oil)

Residual humidity: < 8%

Bulk weight: > 650 kg/m³
(6 tonnes in 8 m³ of storage space)

Ash content: < 0.7%

Tested according to ENplus A1

BENEFITS



Ideal for automatic fuel feeding



Facilitate smooth and easy operation of the heating system



High energy yield, good price-performance ratio



Minimal pollutant emissions, low heating costs and eco-friendly heating



Saves storage space and transport costs



For even greater heating comfort



High application safety, consistently high quality in every delivery and from all sites

PACKAGING

- Bags up to 15 kg
- Big bags up to 1.000 kg
- Loose



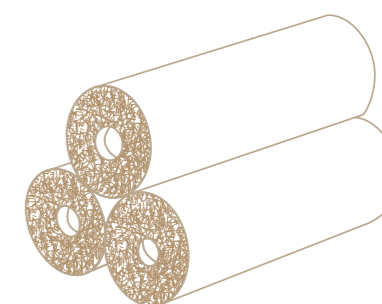

ENERGY

Briquettes

BRIQUETTES



Briquettes offer an environmentally conscious and intelligent alternative for heating. Recycled from sawdust from the timber

industry, briquettes provide environmentally friendly heat in a modern oven.

FEATURES

- ≡ Low in pollutants and emissions
- ≡ Ecologically sensible and economically recommended
- ≡ Burns with minimal smoke.
- ≡ Without binders or additives
- ≡ Briquettes can be packed, stacked and stored cleanly in the smallest of spaces
- ≡ Each briquette has the same size, the same dryness and the same high energy value
- ≡ The round shape of briquettes with their distinctive hole in the middle ensures an optimal combustion process
- ≡ Protect briquettes from humidity during transportation and storage
- ≡ The compacted chips expand during heating.
We recommend breaking up the briquettes twice or thrice

TECHNICAL DATA

- ≡ Briquettes comply with ÖNORM EN ISO 17225-3 and DIN PLUS
- ≡ Austria quality mark
- ≡ Energy value: > 4.9 kWh/kg (2 kg briquettes = 1 litre of heating oil)
- ≡ Residual humidity 8%
- ≡ Dimensions: Diameter: 92 mm, length ~ 29 cm, diameter of the hole in the middle: 22 mm

PACKAGING

- ≡ Packet up to 10 kg
- ≡ A100 packets 10 kg = 1.000 kg = 1 pallet



PALLET BLOCKS AND PACKAGING TIMBER

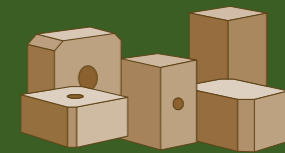

Pages 78-81
Pallet blocks



Pages 82-85
Packaging timber

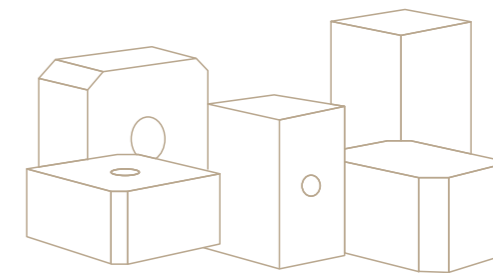

PALLET BLOCKS AND PACKAGING TIMBER

Pallet blocks

PALLET BLOCKS



MATERIAL

The base materials are natural coniferous wood and recycled waste wood chips. When the glued chips are pressed under high pressure and high temperature, a homogeneous, high-quality timber-based material is produced. Pallet blocks with the advantages of boards made of grown timber (deflection and elasticity) give you high-quality pallets.

QUALITY

EUROBLOCK pallet blocks are manufactured according to strict quality criteria and production is monitored by SGS. Due to major product and application advantages, EUROBLOCK pallet blocks have been approved by EPAL, essential rental pools and many large end-users.

EXPORT REGULATIONS

EUROBLOCK pallet blocks are considered to be “no-solid wood” and do not have to undergo any special treatment. See “no-solid wood” statement on: euroblock.com

KEY BENEFITS



- No cracking
- Low storage space requirement
- Low repair intervals



- Great nail-extraction resistance
- Higher service life
- Consistent quality



- Very good operational reliability in automated pallet production and in computer-controlled high-bay warehouses
- Ready for installation
- Improved productivity
- No investment for cutting and planing systems
- No waste, no rejects



- No drying costs – the residual humidity content after production is approx. 10%
- Size accuracy with constant humidity
- Form stability in the event of temperature fluctuations



- Environmentally friendly wood product made of natural coniferous wood chips and/or waste wood/recycled material
- Free of CFCs
- Biodegradable



- “No-solid-wood” material within the meaning of international regulations for the treatment of wood packaging – ISPM 15
- No SIREX treatment required
- No mould or insect infestation

Euroblock pallet blocks made of chipboard – for pallets and timber packaging of all kinds. Special heights from 60–120 mm on request.



Pallet blocks with squared corners

LENGTH X WIDTH in mm	STANDARD HEIGHT in mm	DRILL HOLE in mm
100 x 145	78 / 75 / 90 / 95 / 100	- / 32
145 x 145	78 / 90 / 100	- / 40
(EUR) / EPAL	78 Repair block with spot	- / 32
70 x 70	70 / 75 / 78 / 82 / 85 / 90 / 95	
75 x 75	75 / 78 / 85 / 90 / 95 / 100	
73 x 90	75 / 78	
75 x 95	75 / 78 / 90 / 95	
75 x 115	78 / 75 / 90 / 95	
75 x 133	78 / 75 / 90 / 95	18
85 x 85	75 / 78 / 85 / 90 / 95	
90 x 90	70 / 75 / 78 / 85 / 90 / 95 / 100	
78 x 98	90 / 95	20
78 x 118	90 / 95	20
78 x 133	90 / 95	- / 20
90 x 135	70 / 75 / 78 / 85 / 90 / 95 / 100	
93 x 115	78	26
95 x 95	75 / 78 / 90 / 95 / 100	- / 20
95 x 138	65 / 78 / 90 / 95	32
95 x 160	78 / 95	

CP pallet blocks

LENGTH X WIDTH in mm	STANDARD HEIGHT in mm	DRILL HOLE in mm
78 x 98	78 / 75	20
78 x 118	78 / 75	20
78 x 133	78 / 75	- / 20

Paper pallets blocks

LENGTH X WIDTH in mm	STANDARD HEIGHT in mm	DRILL HOLE in mm
50 x 75	78 / 90 / 95	-



READ THE DIMENSIONS CORRECTLY

78 x 98 x 78
Length Width Height

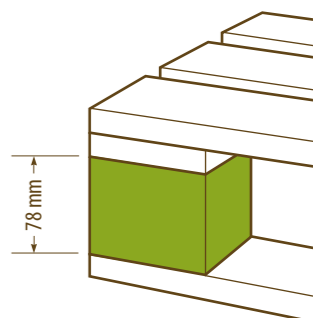

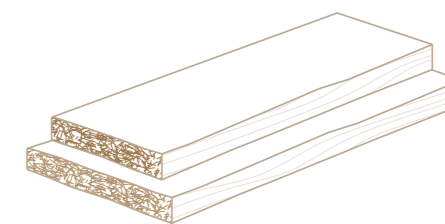

PALLET BLOCKS AND PACKAGING TIMBER

Packaging timber

PACKAGING TIMBER



UNTERBERNBACH DELIVERY PLANT

Spruce – fir – pine

*Fresh and artificially dried,
on request*

THICKNESS x WIDTH (STANDARD) in mm	LENGTH in m
12 x 70	2.50 – 5.00
16 x 70	2.50 – 5.00
16 x 90	2.50 – 5.00
17 x 78	2.50 – 5.00
17 x 98	2.50 – 5.00
17 x 115/135	2.50 – 5.00
18 x 89/130	2.50 – 5.00 *
18 x 140/160/180	2.50 – 5.00 *
21 x 95	2.50 – 5.00 *
22 x 100	2.50 – 5.00 *
22 x 145	2.50 – 5.00 *
25 x 100	2.50 – 5.00 *
75 x 90	2.50 – 5.00 *
76 x 96	2.50 – 5.00 *

UELZEN DELIVERY PLANT

Pine

*Fresh and artificially dried, on request,
blueness protection treatment possible*

THICKNESS x WIDTH (STANDARD) in mm	LENGTH in m
12 x 70	2.00 – 2.40
14 x 70	2.00 – 2.40
15 x 75	2.00 – 2.40
17 x 78	2.00 – 2.40
17 x 98	2.00 – 2.40
17 x 118	2.00 – 2.40
17 x 133	2.00 – 2.40
22 x 78	2.00 – 2.40
22 x 98	2.00 – 2.40
22 x 143	2.00 – 2.40
22 x 200	2.00 – 2.40
76 x 76	2.00 – 2.40
78 x 98/143	2.00 – 2.40
90 x 90	2.00 – 2.40

LAUTERBACH DELIVERY PLANT

Spruce – fir – pine

*Fresh and artificially dried on request,
blueness protection treatment possible*

THICKNESS x WIDTH (STANDARD) in mm	LENGTH in m
12 x 70	2.00 – 5.00
14 x 75	2.00 – 5.00
14 x 95	2.00 – 5.00
17 x 78	2.00 – 5.00
17 x 98	2.00 – 5.00
17 x 115/133	2.00 – 5.00
22 x 100	2.00 – 5.00 *
22 x 120	2.00 – 5.00 *
22 x 145	2.00 – 5.00 *
25 x 100/125	2.00 – 5.00 *
75 x 95	2.00 – 5.00 *
78 x 78	2.00 – 5.00 *
78 x 98	2.00 – 5.00 *
96 x 96	2.00 – 5.00 *

* dry also available

CUT

Long or fixed cut, e.g., 800 / 1.000 / 1.140 / 1.200, etc.

Special cuts as well as a variety of other sizes are
available on request.



LITTER



Pages 88-89

Litter

LITTER

For a litter of wood chips with a large volume, Pfeifer Timber Span is just the right choice. The box stays bright and pleasant for a long time. Best of all, your barn is filled with the scent of fresh wood. Due to its purity and the sifting out of all fine

DETAILS

- Pure spruce and fir chips
- Free of chemical additives
- Free of dust
- High absorbency and large litter volume
- Wood chips absorb humidity very well and have a pleasant smell
- Humidity: max. 12%



components, this product is particularly suitable for horses that react to dust. The wood chips offer a high volume and excellent absorbency. A bale weighs 25 kg and corresponds to a litter volume of approx. 600 litres.

PACKAGES

- Bale size and weight: 80 x 40 x 40 cm; 25 kg
- Package volume: 135 l
- Litter volume: 600 l
- Delivery by disposable pallets
- One lorry's worth corresponds to 32 pallets with 15 bales each = 480 bales = 12,000 kg
- Pallet height (incl. bales) approx. 2.8 m



PÖLKKY SAWNTIMBER

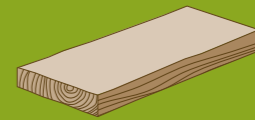

Pages 92-94
Sawn timber

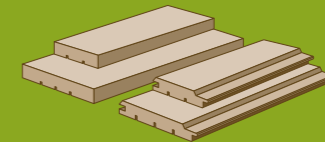

Page 95
**Profiled timber
exterior**

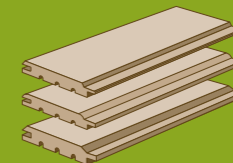

Page 96
**Profiled timber
interior**

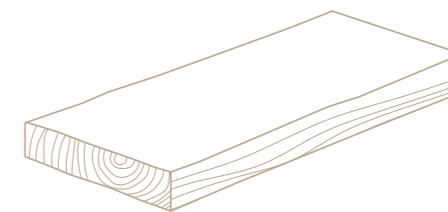

SAWN TIMBER

Sawn timber

SAWN TIMBER

Pölkky's sawn timber is made from slowly grown Nordic spruce or pine, is characterised by high density, and exhibits excellent wood and surface qualities.

After cutting, the sawn timber is technically dried to the pre-defined humidity content.



RANGE

Type of wood: Spruce / pine

Humidity:

Special drying: 8%, 10%, 12%, 14%

Export drying: 18%

Length: Lengths of 1.8 to 5.4 m, 30 or 10 cm modules.
Custom batches and precision cuts as per special order, tolerances ± 2 mm

Quality: Furniture planing quality (U/S), fifths (V), saw-cutting (SF), sixths (VI), packaging material (Schaalboard), waste/centre layers (VII)

Our products are graded according to Nordic timber grading rules. Custom grades can be made to order.

Standard size o = Pine, x = Spruce

MM	50	75	100	125	150	175	200	225
16		x						
19		o	o	o	o			
22		x	ox	x	x	x	x	
25		o	ox	o	o	o	o	
32		ox	ox	ox	ox			
36		x	x	x	x			
38		ox	ox	ox	ox			
44		x	ox	ox	ox			
47		x	x	x	x		x	x
50	o	ox	ox	ox	ox	ox	ox	ox
63				ox	ox	ox	ox	ox
75		o		ox	ox	ox	ox	ox

Standard sizes on the table: other sizes on request.

PROFILED TIMBER EXTERIOR



SIGNIFICANT ADVANTAGES

- Pölkky's profiled timber is made from Nordic pine and spruce
- Pölkky's profiled timber is also available with surface treatment
- Slowly grown wood, high density, maximum wood quality, maximum surface quality

RANGE

Length: The boards are produced in lengths from 3.6-5.4 m as well as fixed lengths, e.g. 3.0 m. Other lengths and profiles possible on customer request. Length starts from 2.4m.

Quality and humidity content: Uniform, tightly grained spruce with solid grown branches and a humidity content of 16-18%.

Surface: Fine sawn.

Surface treatment: Primed using environmentally friendly, water based alkyl resin. Top coating can be done with any conventional exterior use paint. Standard colour is white, other colours on request.

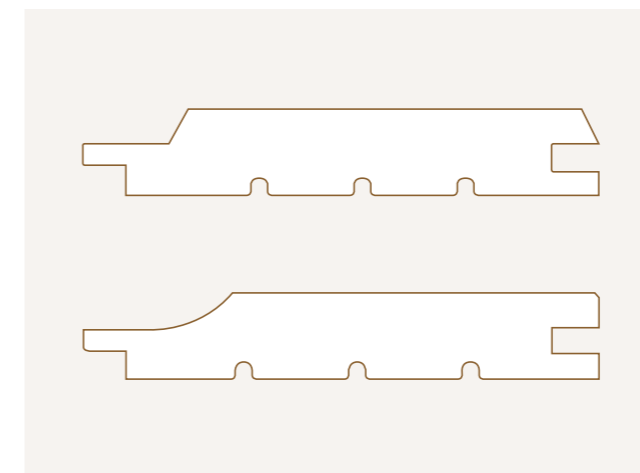

PROFILE	DENSITY mm	WIDTH mm
UTV	20	95 / 120 / 145
UTV	23	95 / 120 / 145
UTV	28	170
UTK	20	120/145
UTK	23	145
UYV	23	120
MITT	20	95 / 120 / 145

Standard sizes on the table: other sizes on request.

PROFILED TIMBER INTERIOR



SIGNIFICANT ADVANTAGES

- Pölky's profiled timber is made from Nordic pine and spruce
- Slowly grown wood, high density, maximum wood quality, maximum surface quality

- Pölky's profiled timber is also available with surface treatment

RANGE

Length: Products are produced in lengths ranging from 3.6 to 5.4 m or fixed lengths e.g. 2.1 m.

Quality and humidity content: Solid grown branches, pine or spruce, humidity content 16% or per customer request.

Surface refinement: Profiled wood can be treated with a wide array of lacquers, paints, oils and waxes.

Packaging: The panels are packed in practical, user-friendly sizes and ready for transport. Interior panels are wrapped in reusable shrink wrap protecting the products from exterior humidity, contamination and sunlight. The packaging is easy to handle. Package sizes as per customer request: 300 x 700 mm, 500 x 1.100 mm, 1.000 x 1.100 mm. Bar codes and labels as per customer request.

Also available in special lengths and sizes in addition to standard products.

PROFILE	SIZE mm
PTGV	14 x 120
PTGW	14 x 95
Softline	14 x 95
Softline	14 x 120
Log panel	20 x 145
Log panel	20 x 170
Log panel	20 x 195

Standard sizes on the table: other sizes on request.

PROFILE	SIZE mm
PTGV	9/12/14 x 95/120/145
Softline	12/14/19 x 95/120/145
Log panel	20/22/28 x 145/170/195/220

Standard sizes on the table: other sizes and profiles on request.

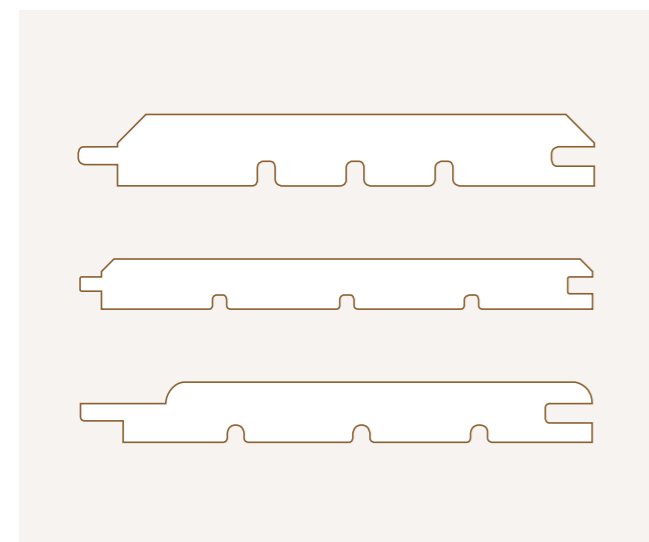

PÖLKKY TIMBER CONSTRUCTION

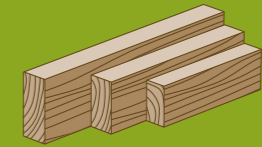

Pages 100–103

Frame wood/logs

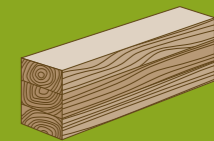

Pages 104–106

Glulam

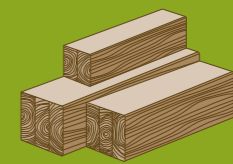

Page 107

**Glulam
posts**

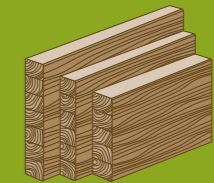

Page 108

Resawn glulam

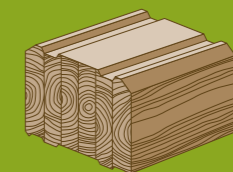

Page 109

**Glulam
elements**

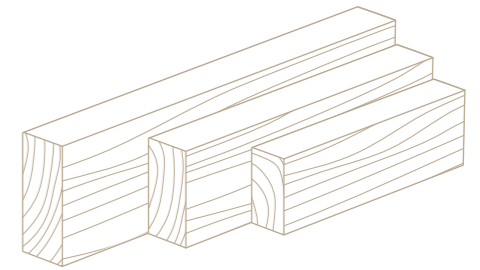

TIMBER CONSTRUCTION

Frame wood/logs

FRAME WOOD/LOGS



Pölkky frame timber is made from Nordic pine and spruce and is characterised by an ideal mix of strength and durability. Graded by strength class, the wood is 48 mm thick and starts

with a width of 98 mm. Standard size is 39 to 48 mm. Standard widths are from 45 to 223 mm. The products are graded into strength classes mechanically or visually.

RANGE

Length: Frame timber is sold in lengths from 3.0 to 5.4 m. Up to 13 m in length with finger joints.

Quality and humidity content: The products are made from Nordic pine or spruce and meet all standard qualities and humidity content values.

Surface: Planed on 4 sides

Packaging: Package size as per customer request.
300 x 1.100 mm, 500 x 1.100 mm, 1.000 x 1.100 mm.
Bar codes and labels as per customer request.

Standard length: 1.8 to 5.4: If finger-jointed up to 13.5 m

Standard width: From 1 m to 1.15 m

Standard products

PRODUCT	WOOD		DIMENSION / SIZE	
Frame timber for partitioning walls	Pine/spruce	Length with finger joints	44 x 66 44 x 66	(Length 2.55 or 2.7 m)
PE	Pine	(small radius)	45 x 45/70/95/120/145/170/195	
PAR	Pine/spruce		45 x 45 48 x 48 48 x 73	
PAR, strength class C24	Pine/spruce	Length with finger joints	45 x 48 49 x 98/123/148/173/198/223	(Length 6–13.5 m)

Standard sizes on the table: other sizes on request.



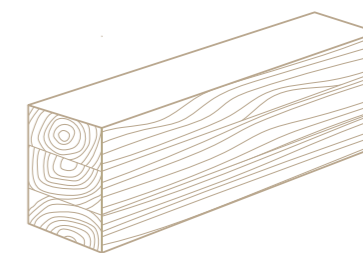

TIMBER CONSTRUCTION

Glulam

GLULAM



RANGE

Type of wood: Spruce / pine

Strength classes: GL24c, GL28c, GL30c, GL30h, GL32c

Length: 1–13.5 m

Surface: Planed on 4 sides

Humidity content: 14-16%

Bonding: PUR (Polyurethane)

Packaging: Individual or package wrapping

Standard packaging size: Length 200–500 mm x width approx. 1.000 mm

Utilisation classes: NK4 / EN 350-2 quality standard, as well as the EN 338 standard

Glulam can be impregnated.

STANDARD SIZES

WIDTH	HEIGHT
90	180 / 225 / 270 / 315 / 360 / 405 / 540
115	180 / 225 / 270 / 315 / 360 / 405 / 450 / 495 / 540
140	180 / 225 / 270 / 315 / 360 / 405 / 450 / 495
165	360 / 450

Standard sizes on the table: other sizes on request.

We also provide other package sizes and dimensions as well as individually cut glulam beams that meet the customer's requirements.

Standard products

STRENGTH VALUES IN N/mm ²	GL24C	GL28C	GL30C	GL32C
Deflection, f m, g, k	24	28	30	32
Vertical tension II, f t, 0, g, k	14	16.5	20	19.5
Vertical tension, f t, 90, g, k	0.35	0.4	0.5	0.45
Vertical compression II, f c, 0, g, k	21	24	25	26.5
Vertical compression, f c, 90, g, k	2.4	2.7	3	3
Shear modulus, f v, k	2.2	2.7	3	3.2
Elasticity modulus E mean, E 0, g, mean	11,600	12,600	13,000	13,700
Density kg/m ³ , ρ, g, k	350	380	390	410

Standard sizes on the table: other sizes on request.

GLULAM POSTS



RANGE

Type of wood: Spruce / pine

Strength classes: GL24c, GL30c

Length: 3, 6, 12 m

Surface: Planed on 4 sides

Humidity content: 14-16%

Bonding: PUR (Polyurethane)

Packaging: Individual or package wrapping

Standard packaging size: Height 300–500 mm x width approx. 1.000 mm

Utilisation classes: NK4 / EN 350-2

Glulam can be impregnated.

STANDARD SIZES

WIDTH	HEIGHT
70	70
90	90 / 120
115	115
140	140
190	190

Standard sizes on the table: other sizes on request.

We also provide other package sizes and dimensions as well as individually cut glulam beams that meet the customer's requirements. Our product range also includes impregnated glulam.

Standard products

STRENGTH VALUES IN N/mm ² (Standard C24)	C24	C30
Deflection, f m, g, k	24	30
Vertical tension II, f t, 0, g, k	14	18
Vertical tension, f t, 90, g, k	0.5	0.6
Parallel compression II, f c, 0, g, k	21	23
Vertical compression, f c, 90, g, k	2.5	2.7
Shear modulus, f v, k	2.5	3
Elasticity modulus E mean, E 0, g, mean	11,000	12,000
Density kg/m ³ , ρ, g, k	350	380

Standard sizes on the table: other sizes on request.

RESAWN GLULAM



RANGE

Type of wood: Spruce / pine

Strength classes: On request

Length: 3–3.5 m

Surface: Planed on 4 sides

Humidity content: 14-16%

Lamella and joint glue: PUR (Polyurethane), lightweight glue for exterior use

Packaging: Individual or package wrapping

Standard sizes: Widths 42, 45, 56 and 66, height as per customer request. We also provide other packaging sizes and dimensions as well as individually cut beams that meet the customer's requirements.

Standard packaging size: For transport, the products are wrapped in film in practical sizes. Height 150–500 mm x width approx. 1.000 mm. Packaging size also as per customer request.

Utilisation classes: NK4 / EN 350-2 quality standard, as well as the EN 338 standard.

Gulam can be impregnated.

Standard products

STRENGTH VALUES IN N/mm ² (standard GL30C)	GL24CS	GL28CS
Deflection, f m, g, k	28	30
Vertical tension II, f t, 0, g, k	16.5	20
Vertical tension, f t, 90, g, k	0.4	0.5
Parallel compression II, f c, 0, g, k	24	25
Vertical compression, f c, 90, g, k	2.7	3
Shear modulus, f v, k	2.7	3.5
Elasticity modulus E mean, E 0, g, mean	12,600	13,000
Density kg/m ³ , ρ, g, k	380	390

Standard sizes on the table: other sizes on request.

GLULAM ELEMENTS



RANGE

Type of wood: Spruce / pine

Length: 12 m, max. length 13.6 m

Surface: planed on 4 sides

Humidity content: 14–16%, ±2%

Bonding: PUR (Polyurethane)

Packaging: Individual or package wrapping

Standard packaging size: Height approx. 500 mm x width approx. 1.000 mm. Other packaging sizes available on request.

Quality: Pölkky's profiled glulam is made on the basis of the HTT, the Finish Block House Association's quality standard, as well as the EN 338 standard.

Gulam can be impregnated.

STANDARD SIZES

WIDTH	HEIGHT
88	195
114	195
135	195
180	195
202	220
230	220
275	220 / 280

Standard sizes on the table: other sizes on request.

PROFILE OPTIONS

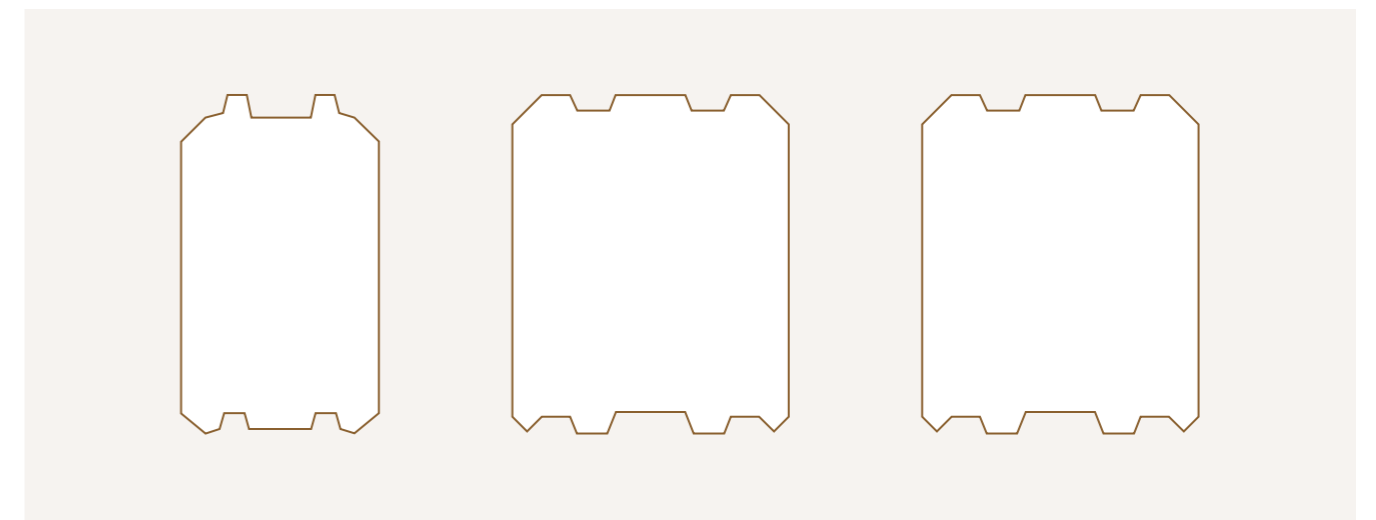

PÖLKKY PRESSURE-TREATED WOOD

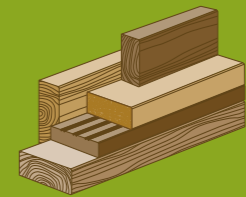

Pages 112–113

**Pressure-treated
wood**











PRESSURE-TREATED WOOD



Impregnation classes:

- Class NTR-A: for structures where the wood comes into contact with soil, occasional contact with water
- Class NTR-AB: only for structures where the wood does not come into contact with soil or water

Standard products in green and brown

PROFILE	SIZE	CLASS	COLOUR	
PAR	21 x 45	AB		
Decking	21 x 95	AB		
Decking	25 x 95 chamfered	AB		
Decking	28 x 95/120/145	AB		
'Profiled' decking	28 x 95/120/145	AB		
'Profiled' decking	28 x 95 chamfered	AB		
Battens	45 x 45	AB		
PAR	48 x 48/98/123/148/198	A/AB		
Glulam Post	70 x 70	A		
Glulam Post	90 x 90	A		
Glulam Post	115 x 115	A		
Glulam Post	140 x 140	A		
Glulam Post	190 x 190	A		

Standard sizes on the table: other sizes on request.



PÖLKKY WOOD FLOORS

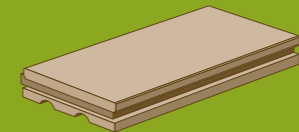

Pages 116-117

Solid wood floorings

SOLID WOOD FLOORINGS



Wooden boards create a healthy and warm interior ambience and are environmentally friendly. Down the line, the surface can be sanded and re-treated, making it look like new again.

The boards are made from wood of high density, technically dried and equipped with a groove/tongue on all four sides. Pölkky wood floors exhibit high strength, making them very durable, and their surface quality is excellent.

DETAILS

- Standard sizes: 28 x 95, 28 x 120, 28 x 145
- With groove and tongue but not technically dried, which must be considered before use
- Groove and tongue are end matched

QUALITY

- PRIME: Best quality, bright, fresh knots. Individual, dark, fresh knots can occur, occasional resin galls are possible.
- ECO: Does not meet the requirements of the PRIM surface quality.

HUMIDITY CONTENT

- PRIME: 8–10%
- ECO: 14–16%

SURFACE REFINEMENT

- Pölkky wood floors can be coated using common lacquers, oils, waxes and paints.

PACKAGING AND LENGTHS

- Wrapped in shrink foil.
- Packaging size as per customer request.
- Bar codes and labelling as per customer system possible.
- The products are sold in lengths ranging from 1.8 to 5.4 m and fixed lengths of e.g. 2.1 m:

Other profiles and lengths are available on request.

SURFACE

- Excellent planing quality. Pre-fabricated groove and tongue boards reduce off-cuts and make installation easy. Relief grooves on the underside support the board's dimensional stability and improve ventilation. Additionally, the boards are chamfered.

PROFILE	SIZE mm
HLL/PP	28 x 95



PÖLKKY LITTER



Pages 120–121

Litter

LITTER



The Pölkky Lumi Base and Shavings are the world's first wood shavings products baled in a recyclable kraft paper. The CO₂ footprint of manufacturing a paper packaging is 50–70% smaller than a similar plastic packaging. The kraft paper wrapping

can be fully recycled and it thus further reduces CO₂ footprint with additional 50% compared to the plastic alternative.

3 key factors: 99% dust free, up to 3x absorption capacity ecological packaging material.

DETAILS

- Sustainably sourced virgin pine and spruce wood from Northern Finland
- Biodegradable, a good source of nitrogen to the soil
- Hygienic & healthy: Slow growing northern pine heartwood extractives are active antioxidants and pinewood volatile

compounds have been found to be antibacterial against several bacterial strains

- Kiln dried, highly absorbent, and naturally sterile with an extremely low dust level

QUALITY

■ BASE

- Bale sizes: 10, 15 and 20 kg
- Packaged in recyclable kraft paper
- Particle size between 0.5 and 1.9 mm
- Capable of absorbing all liquids including oil

■ SHAVINGS

- Packaged in recyclable kraft paper
- Bale volume 550 litres
- Highly absorbent and can absorb 250% of its weight

■ FARM

- Packaged in recyclable plastic - can be stored outside
- Bale weight 20 kg
- Using only kiln dried pine and spruce shavings from sawn timber
- All-round product consisting of a selection of small and larger particles
- Highly absorbent, absorbing over two times its own weight in liquid



CURRENT PRODUCT INFORMATION

What our customers trust in



Documents



Inquiry



CONTACT

**We will be
happy to help**

Pfeifer Timber GmbH

Fabrikstraße 54
A-6460 Imst

Tel. +43 5412 6960 0
Fax +43 5412 6960 200

info@pfeifergroup.com
www.pfeifergroup.com



Site notice

EDITOR

Pfeifer Timber GmbH
Fabrikstrasse 54
A-6460 Imst

Legal Notice

All contents of this brochure are provided without guarantee. We take no responsibility for the accuracy, completeness or timeliness of the information. Changes are possible at any time and without prior notice. Status: June 2024

